



Aquapura HT



AQUAPURA 14HT (INVERTER P 6-16)
AQUAPURA 8HT (INVERTER P 3-10)

USER AND INSTALLATION MANUAL

Esteemed Client,

We would like to thank you for your choice when you acquired an equipment for sanitary water heating.

AQUAPURA INVERTER HT14 aero-thermal system will surely meet all your expectations and provide many years of comfort with maximum power saving.

Our organization dedicates much time, energy and economic resources in order to develop innovations that will promote power saving in our products.

Your choice has demonstrated your good sense and concern with power consumption, a matter that affects the environment.

We have taken on a permanent commitment to conceive innovative and efficient products so that this rational use of energy can actively contribute to the preservation of the environment and natural resources of the planet.

Keep this manual whose objective is to inform, alert and advise about the use and maintenance of this equipment.

Our services are always at your disposal. Feel free to call upon us!

INDEX

1	INFO.....	5
2	SAFETY INFORMATION	5
2.1	Danger Info.....	6
2.2	Warning Info.....	7
3	GENERAL INFO.....	7
3.1	Manufacturer Responsibility.....	7
3.2	Installer responsibility	7
4	TRANSPORT	8
5	PRINCIPLE OF OPERATION.....	9
6	UNIT OVERVIEW	9
7	UNIT DIMENSIONS	10
7.1	Aquapura 8HT.....	10
7.2	Aquapura 14HT	11
	11
8	TECHNICAL INFO.....	12
9	PERFORMANCE.....	14
9.1	AQUAPURA 8HT	14
9.2	AQUAPURA 14HT/ AQUAPURA 14 HT T.....	14
10	INSTALLATION	15
10.1	Installation place	15
10.2	Condensate drainage	15
10.3	Hydraulic installation.....	16
10.4	Water filter.....	16
10.5	Circuit water quality.....	17
10.6	Glycol (%).....	17
10.7	Temperature probes info	18
11	ELECTRICAL REQUIREMENTS.....	18
11.1	Main specifications.....	18
11.2	Electrical main specifications/ protection devices.....	19
11.3	Connection between external unit and display (user interface)	19
11.4	Connection terminals - Inputs.....	20
11.5	Digital input configuration	21
11.6	Connections terminals – Outputs.....	22
12	ROOM THERMOSTAT INSTALLATION	22
13	MAIN CONTROLLER --- USER INTERFACE	23
13.1	User interface description.....	23
13.2	Unlock screen	24

13.3	Operation mode switch.....	24
13.4	Setting target temperature	25
13.5	Setting interface display and function	25
13.6	Time setting.....	26
13.6.1	System time setting.....	27
13.6.2	Mute timer setting	27
13.6.3	Power timer setting.....	28
13.7	Temperature curve.....	29
13.8	Color display calibration.....	32
13.9	Electric Heating	32
13.10	Status interface display	33
13.11	Fault list	33
14	MAIN CONTROLLER –INSTALLER INTERFACE	37
14.1	Installer parameters	38
14.2	Compensation curve - Outdoor temperature Vs setpoint	40
14.3	Output/ input state of digital / analogic contacts.....	40
14.4	Info of software version	41
15	ALARM.....	42
15.1	Alarm – Electronic control fault table	42
15.2	Alarm – Frequency conversion board fault table.....	44
16	TROUBLESHOOTING	45
17	APPENDIX 1 – HYDRAULIC SCHEMES	47
17.1	Hydraulic schemes glossary	47
17.2	Central Heating and Cooling	48
17.3	Central Heating and Cooling with buffer tank	49
17.4	Central Heating and Cooling with buffer tank + DHW	49
17.5	Central Heating and Cooling + DHW	50
17.6	Domestic hot water.....	51
18	WARRANTY.....	51

1 INFO

This manual is intended as an aid to qualified service personnel for proper installation, operation and maintenance of the Heat Pump.

Read this manual carefully before attempting to install or operate the Heat Pump. Failure to follow these instructions may cause a fault of the Heat Pump, resulting in electrical shock, scald injury and/or property damage.

Installer:



Before leaving the premises, review this manual to be sure the Heat Pump has been installed correctly.

Start or operate the unit and check that the parameters are within the normal operating range.

2 SAFETY INFORMATION

To prevent the users and others from the harm of this unit, and avoid damage on the unit or other property, and use the heat pump properly, please read this manual carefully and understand the following information correctly.



The piping connection and wiring should be installed according to the local legal laws and regulations as well as the qualified professional.

 DANGER	<p>Any process that the supplier believes may pose a danger of personal injury and/or material damage must be marked with a DANGER SIGN.</p> <p>As a means of further classifying the hazard, the symbol will be accompanied by one of the following words:</p> <ul style="list-style-type: none"> • DANGER: when the operator and/or people in the vicinity of the equipment are subject to personal injury. • ATTENTION: when nearby equipment and/or materials are subject to material damage.
 INFO	<p>All information that the supplier believes can contribute to the best performance and conservation of the equipment must be marked with the information sign.</p>



 WARNING	<p>Children must not play with the device.</p> <p>Cleaning and maintenance must not be carried out by children without supervision.</p> <p>This appliance can be used by children aged 8 years and over and by people with limited physical, sensory or mental capabilities or lack of experience and knowledge if they are supervised or have received instructions concerning the use of the appliance in a safe way and understand the risks involved;</p>
---	---

2.1 Danger Info



INSTALLATION:

	Description
 DANGER	The heat pump must be installed by qualified personals, to avoid improper installation which can lead to water leakage, electrical shock or fire.
	Please make sure that the unit and power connection have good earthing, otherwise may cause electrical shock.
	Unit refrigerant is flammable.
	<ul style="list-style-type: none"> • Carry out brazing or welding only on empty pipes, free from any residual lubricating oil; • Do not place flames or other heat sources near pipes that contain refrigerant; • Do not operate with an open flame near the unit;

HP RUNNING:

	Description
	It is prohibited to place fingers, hands or other objects on the fans. Failure to do so can cause serious injury or equipment destruction.
 DANGER	When there is something wrong or strange smell, the power supply needs to be shut off to stop the unit. Continue to run may cause electrical short or fire.

MAINTENANCE:





	Description
 DANGER	When the heat pump need to be moved or installed again, please entrust dealer or qualified person to carry it out. Improper installation will lead to water leakage, electrical shock, injury or fire.
 DANGER	Maintenance or repairs must be carried out by the seller or qualified technician. Improper intervention could cause water leakage, electric shock, injury or fire.
	The user is prohibited from carrying out any intervention at HP. Failure to do so can cause water leakage, electric shock, serious injury or fire.

2.2 Warning Info

INSTALLATION:

	Description
 DANGER	The unit CANNOT be installed near the flammable gas. Once there is any leakage of the gas, fire can occur.
	Make sure that the basement of the heat pump is strong enough, to avoid any decline or fall down of the unit.
	Make sure that there is circuit breaker for the unit, lack of circuit breaker can lead to electrical shock or fire.

MAINTENANCE:

	Description
 PERIGO	Please switch off the power for clean or maintenance.
	It is expressly prohibited to make any type of chamfering in the protection fuses. Fuses must be replaced by a qualified person.
	Do not spray BC with flammable liquids, it may cause fire.
	Do not use any cleaning agents containing sand, soda, acid or chloride as these may damage the surface.

3 GENERAL INFO

3.1 Manufacturer Responsibility

Our products are produced according to the requirements of various European Standards.

Always concerned with the quality and performance of our products, we strive continuously to improve them. Therefore, we reserve to the right to modify at any time the information described herein.

As manufacturers we are no longer responsible for the malfunction or even damage of the equipment when:

- The instructions for use are not respected.
- The installation instructions are not respected.
- Lack of maintenance (if required).

3.2 Installer responsibility

The installer is responsible for proper installation of the equipment and start with its operation.

The installer should note the following notes:

USER AND INSTALLATION MANUAL

- Carefully read and follow the instructions of the manuals supplied with the equipment;
- Do the installation in accordance with the standards and requirements given by the manufacturer;
- Do the initial startup of the equipment and check all control points;
- Explain to the user how to do the installation and how to use the equipment;
- Warn the user of the obligation to make the checking and maintenance of the equipment when necessary;
- Supply to the user all the documents provided with the equipment (manual and warranty datasheet).

4 TRANSPORT

The Heat Pump is packed in a cardboard box without a bottom, and is secured to a wood pallet with plastic strapping.

When the heat pump is transported, please keep the unit stand up, otherwise the inner parts of the device may be damaged.



The unit should be transported to the final installation site on a wooden pallet, during transport the heat pump must not be tilted more than 45° (in either direction).

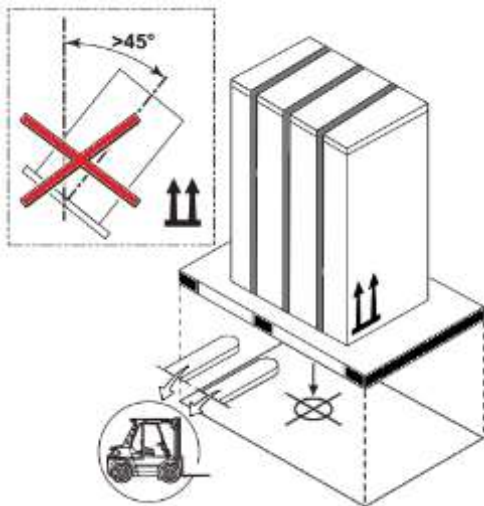

The recommended tools to transport the equipment while it is still on the pallet can be: forklift or pallet.

When transporting the unit make sure that you lift it only from the bottom and always with the unit placed on the pallet. Do not move the unit without assistance.

	Description
 WARNNING	The unit has been tested and inspected prior to shipment from the manufacturer for quality assurance. Carefully inspect the equipment components upon receipt to ensure that the equipment has not been damaged in transit. Confirm that all ordered parts have been received as specified and that unit type, size, and voltage are correct.

5 PRINCIPLE OF OPERATION

Ambient air is drawn in by the fan and passed over the evaporator. The evaporator cools the air, i.e. it extracts the heat it contains. In the evaporator, the heat removed is transferred to the working fluid (refrigerant).

With the aid of an electrically driven compressor, the absorbed heat is "pumped" to a higher temperature level through an increase in pressure and given off to the heating water via the condenser (heat exchanger).

In so doing, the electrical energy is used to raise the heat of the environment to a higher temperature level.

Due to the fact that the heat energy extracted from the air is transferred to the heating water, this type of appliance is referred to as an air to water heat pump.

The air to water heat pump consists of the following main components: Evaporator, fan, expansion valve, low-noise scroll compressor, condenser and the control unit.

In the case of low ambient temperatures, air humidity may accumulate on the evaporator in the form of frost, impairing the heat transfer. The evaporator is automatically defrosted by the heat pump, as required, with the possibility of vapor plumes forming at the air outlet.

6 UNIT OVERVIEW

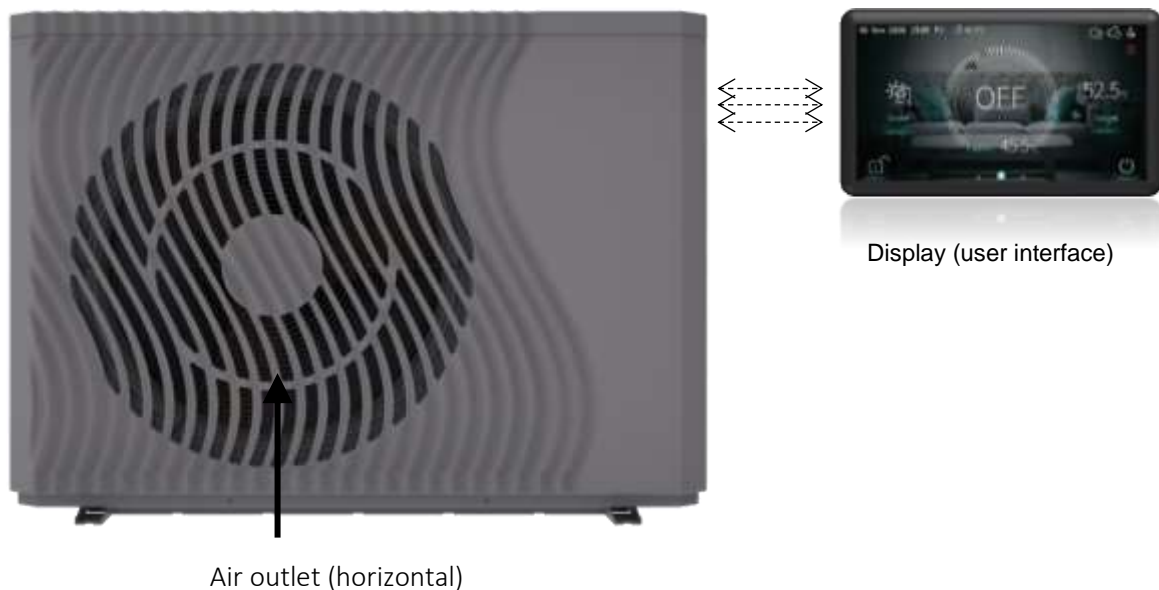

7 UNIT DIMENSIONS

7.1 Aquapura 8HT

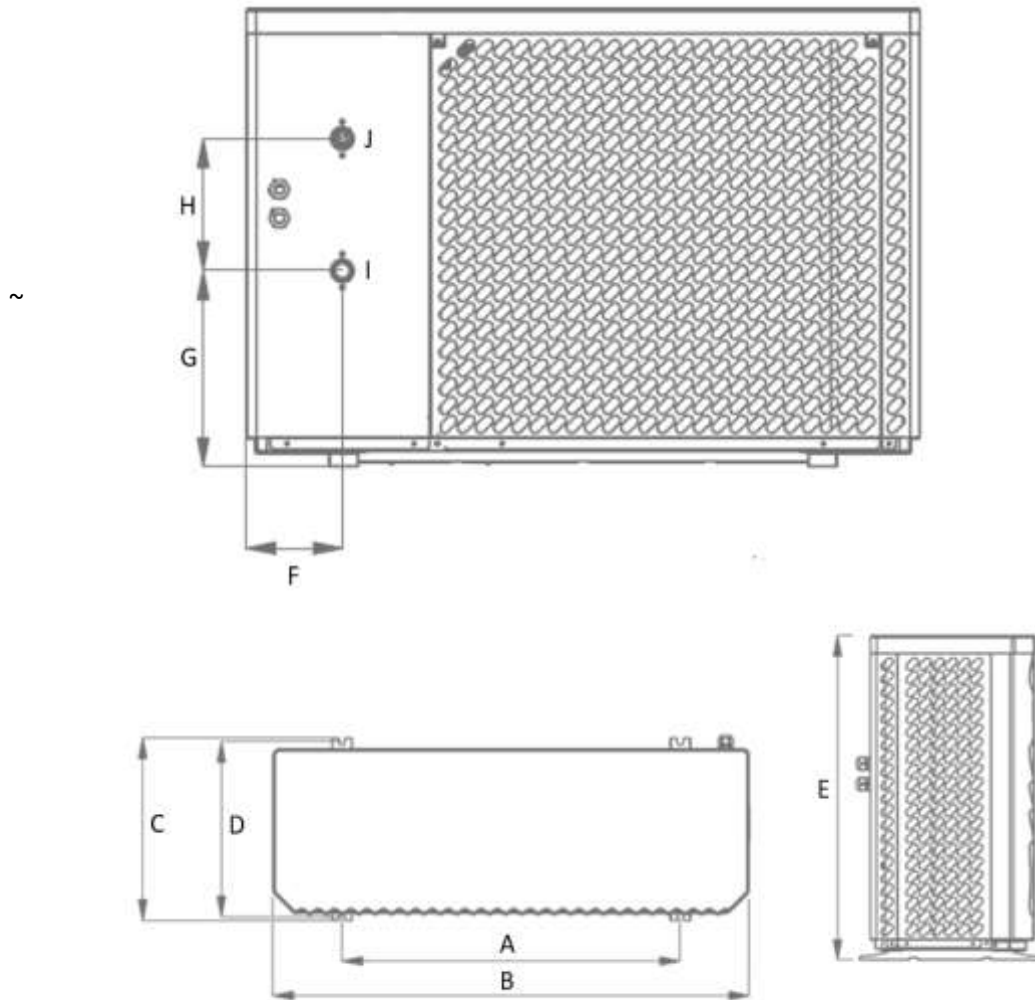

	A	B	C	D	E	F	G	H
Dimension (mm)	830	1167	445	428	795	166	339	229

	I (Inlet Water)	J (Outlet Water)
Dimension (Inches)	1"	1"

7.2 Aquapura 14HT

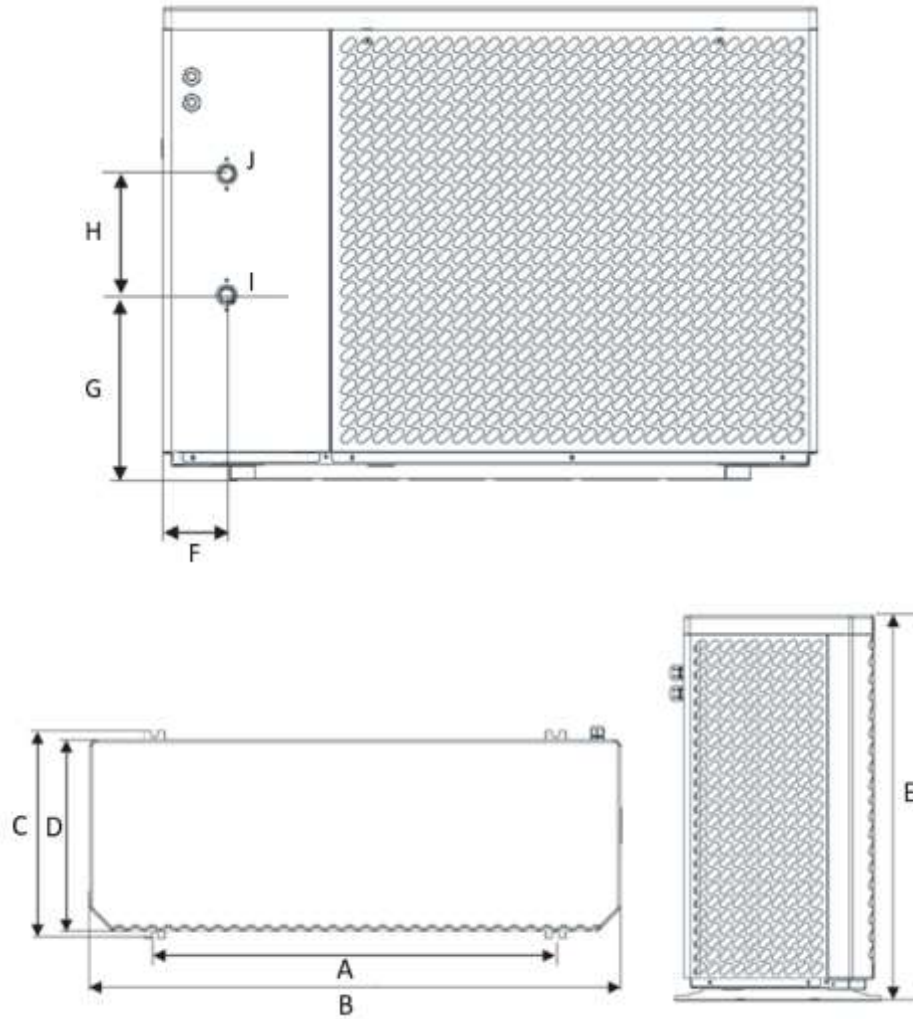

	A	B	C	D	E	F	G	H
Dimension (mm)	975	1287	500	458	928	125	363	238

	I (Inlet Water)	J (Outlet Water)
Dimension (Inches)	1"	1"



INFO

All the units are represented in millimeters

8 TECHNICAL INFO

Aquapura 8HT (Inverter P3-10)		
Powe supply	/	240V~/50Hz
Refrigerant / Charge	/ Kg	R290 / 0,500 / 0,0015
Heating		
Heating capacity range (min/ max)	kW	4,67 ~ 10,3
Electrical power range	kW	0,71 ~ 2,9
Rated thermal power supplied ¹	kW	8.95
Rated electrical power consumption ¹	kW	1,86
COP ¹	/	4,8
Cooling		
Cooling capacity range (min / max)	kW	1,6 ~ 8,51
Electrical power range	kW	0, 78 ~ 2,95
Rated thermal power supplied ²	kW	5,98
Rated electrical power consumption ²	kW	1,64
EER ²	/	3,65
Technical specifications		
Maximum temperature – heating	°C	70
Backup electrical heater	/	Not integrated
Maximum operating current	A	13,5
Maximum power consumed	kW	3,0
Number of compressors	/	1
Compressor typology	/	DC Inverter
Water pump	/	Integrated/ 5
Minimum water flow	m ³ /h	1,0
Internal water pressure drop	kPa	20
Number of fans	/	1
Hydraulic connections (inlet/outlet)	Pol.	1" / 1"
Sound pressure at 1m	dB(A)	43
Sound Power	dB	57
Net weight	Kg	80
Net dimensions (L/ A/ P)	mm	795/ 1167/ 455
Erp / Performance in accordance with EN 14825 – Average climate		
Energy efficiency class (35°C)	--	A+++
SCOP/η	-- / %	5,00 / 197
Energy efficiency class (55°C)	--	A++
SCOP/η	-- / %	3,71 / 146

1) Air temperature (DB/WB) 7°C/6°C; Water temperature (inlet/outlet) 30°C/35°C

2) Air temperature (DB/WB) 35°C/ 24°C; Water temperature (inlet/outlet) 12°C/ 7°C

USER AND INSTALLATION MANUAL

		Aquapura 14HT	Aquapura 14HT-T
Powe supply	/	240V~/50Hz	400V~/3P+N/50Hz
Refrigerant / Charge/CO2 Eq.	/ Kg/ton	R290 / 0,850/0,0025	
Heating			
Heating capacity range (min/ max)	kW	6,18~ 16,70	6,18~ 16,70
Electrical power range	kW	1,45 ~ 4,67	1,45 ~ 4,67
Rated thermal power supplied ¹	kW	14,21	14,21
Rated electrical power consumption ¹	kW	2,83	2,83
COP ¹	/	5,02	5,02
Cooling			
Cooling capacity range (min / max)	kW	3,35 ~ 11,61	3,35 ~ 11,61
Electrical power range	kW	1,52 ~ 4,98	1,52 ~ 4,98
Rated thermal power supplied ²	kW	9,71	9,71
Rated electrical power consumption ²	kW	2,45	2,45
EER ²	/	3,96	3,96
Technical specifications			
Maximum temperature – heating	°C	70	70
Backup electrical heater	/	Not provided	Not provided
Maximum operating current	A	24,5	10,5
Maximum power consumed	kW	5,3	5,3
Number of compressors	/	1	1
Compressor typology	/	DC Inverter	DC Inverter
Water pump	/	Integrated	Integrated
Minimum water flow	m ³ /h	1,6	1,6
Internal water pressure drop	kPa	30	30
Number of fans	/	1	1
Hydraulic connections (inlet/outlet)	Pol.	1" / 1"	1" / 1"
Sound pressure at 1m	dB(A)	42	42
Sound Power	dB	58	58
Net weight	Kg	160	160
Net dimensions (L/ A/ P)	mm	1287/ 928/ 485	1287/ 928/ 485
Erp / Performance in accordance with EN 14825 – Average climate			
Energy efficiency class (35°C)	--	A+++	A+++
SCOP/η	-- / %	4,90 / 193	4,92 / 194
Energy efficiency class (55°C)	--	A+++	A+++
SCOP/η	-- / %	3,76 / 147	3,78 / 148

1) Air temperature (DB/WB) 7°C/6°C; Water temperature (inlet/outlet) 30°C/35°C

2) Air temperature (DB/WB) 35°C/ 24°C; Water temperature (inlet/outlet) 12°C/ 7°C

9 PERFORMANCE

9.1 AQUAPURA 8HT

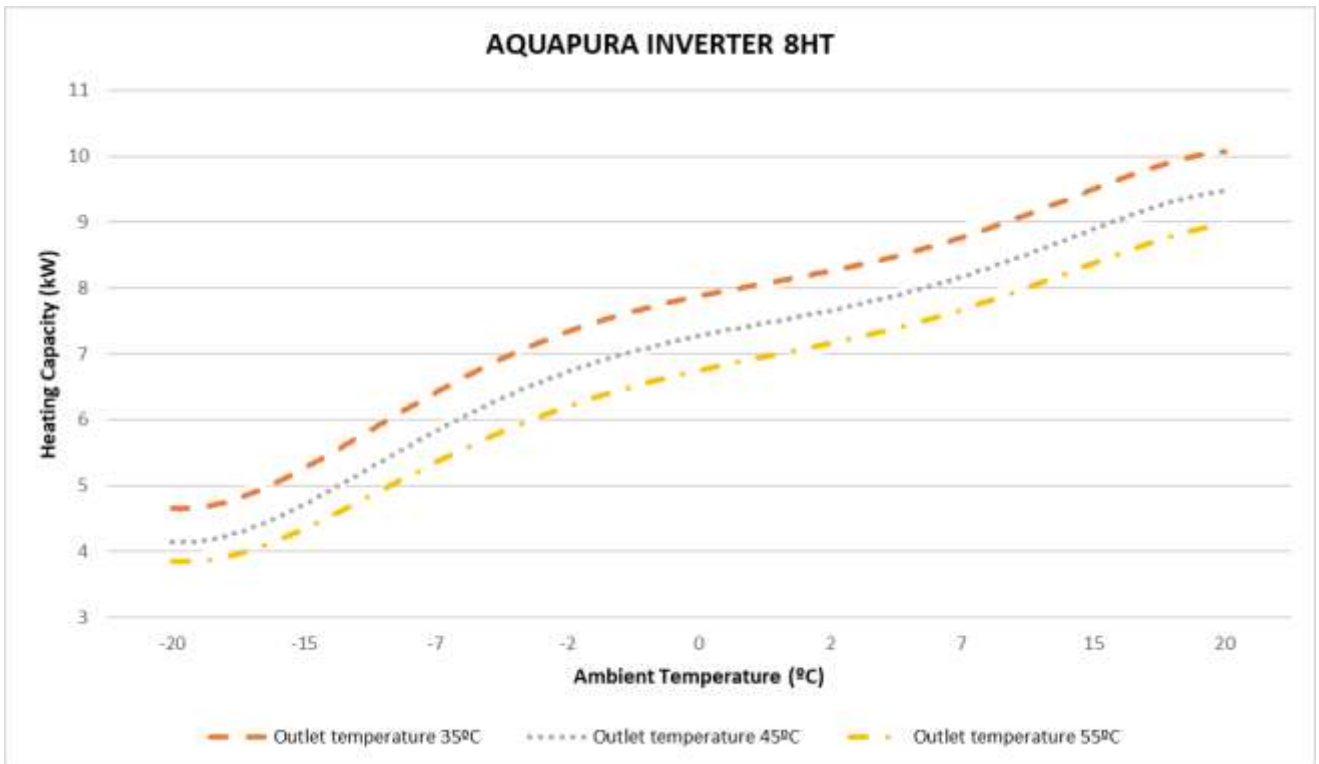

9.2 AQUAPURA 14HT/ AQUAPURA 14 HT T

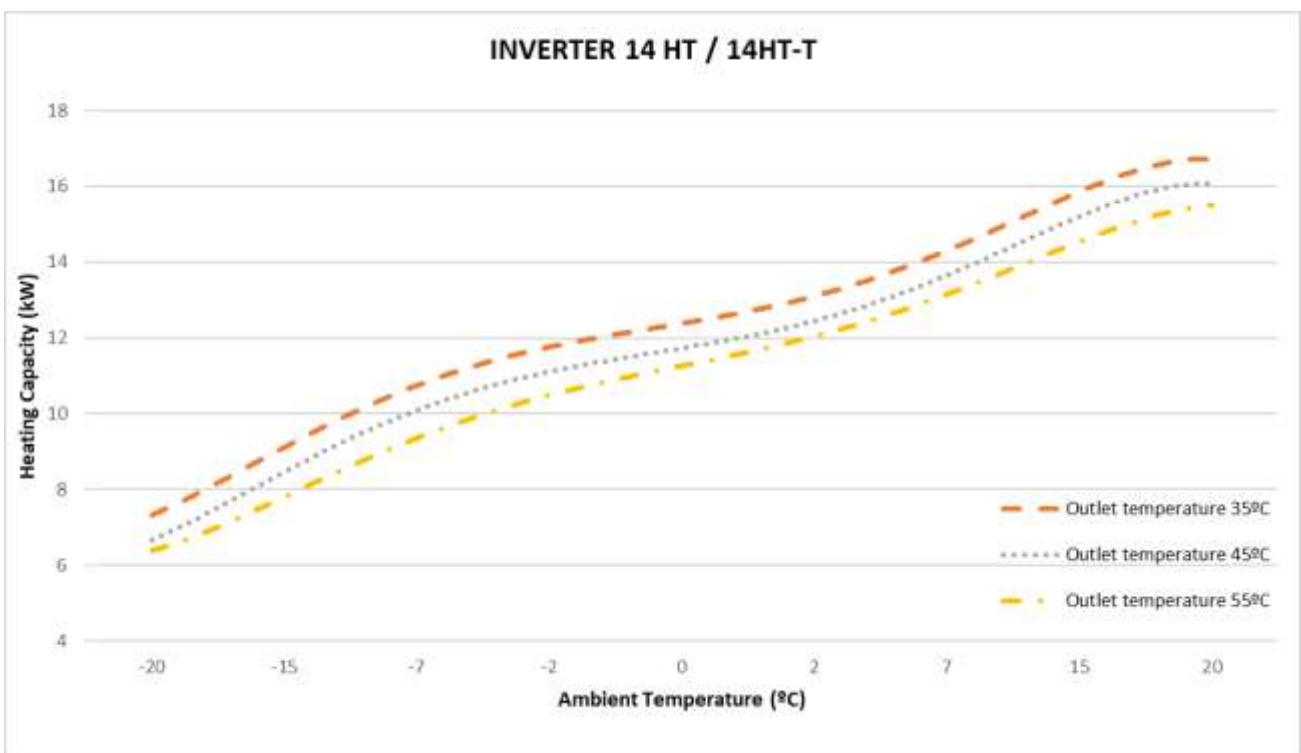

10 INSTALLATION

10.1 Installation place

Before starting any installation procedure, check that the base of the place where the equipment will be placed is perfectly level. This prevents the compressor lubricating oil from working outside the indicated levels.

Look for a place with an even, safe and resistant floor, preferably in concrete, taking into account the weight of the machine. At a minimum, the concrete base should have a thickness of 150mm and if possible above ground level (100mm)

During its operation, the heat pump can create water originated by the condensation of the evaporator, being necessary to prepare the installation site with a drain point to facilitate its drainage.

Another important point is the minimum distances that the equipment must comply with in relation to walls, ceilings or any type of obstacles that may impair its performance and make access difficult, both during installation and in any maintenance operations.

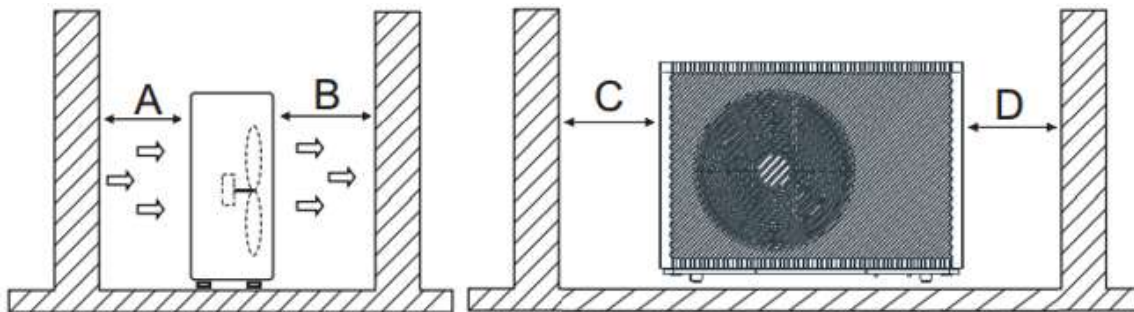

⚠	Requirements			
	A	B	C	D
	>500mm	>1500mm	>1000mm	>500mm

The walls and roof of the technical room can be insulated with sound absorption panels if the noise level of the heat pump is too high.

The feet of the HP must be fixed to the base, preventing the equipment from moving with the vibrations caused by its normal operation.

10.2 Condensate drainage

In normal operation, water is produced as a result of condensation in the evaporator and defrost cycles. Prepare a good drainage system to prevent the formation of ice on the floor, thus avoiding possible falls. The drain tube must have a diameter of min. 50mm, the water discharge must be carried out to the sewer and must not be exposed in places with frost formation.

10.3 Hydraulic installation

Take the following points into account when executing the hydraulic circuit:

- Reduce as much as possible the number of bends in the pipes to reduce pressure drops in the installation;
- Ensure system fittings, dowels, water pumps and valves are designed for full flow through the facility. Obstructions can impact the unit's performance and the effectiveness of the central heating system;
- The piping must be free from dirt, if possible, clean the installation;
- Load the installation to check for possible leaks and then isolate the entire installation;
- Place an expansion vessel in the installation, the pressure in the expansion vessel must be 0.5 bar higher than that of the installation;
- Check if the equipment's flow switch is working properly. Simulate a flow failure by closing a strainer and check if the controller stops the BC operation and issues an alarm message;
- The hydraulic connections between the BC and the central heating circuit must be made with a flexible tube to avoid the transmission of vibrations;
- Before putting the BC into operation, check that the hydraulic circuit is full and properly bled. If the hydraulic circuits are sectioned, each circuit must be bled, ensuring that it eliminates all air pockets in the installation;
- Place a thermometer and a pressure gauge at the water inlet and outlet to facilitate inspection;
- The pressure placed on the hydraulic circuit must be between the following values: Min. 1.5 bar and Max. 2 bar.

 warning	The hydraulic connection should be installed according to the local legal laws and regulations as well as the qualified professional
--	--

10.4 Water filter

The filter allows block any impurities present in the hydraulic circuits. Residue left in the heater pipes will damage the heat exchangers and cause the heat pumps to malfunction. It is recommended install the filter in the heater return line, especially if no buffer storage is present. It is indispensable in order to prevent serious damage to the heat exchanger.

Note 1: The filter must contain a filtering mesh with holes that do not exceed one millimeter.

Note 2: The filter should be kept cleaned and inspected periodically to maintain your condition, cleanliness and ensuring the proper functioning of Heat pump

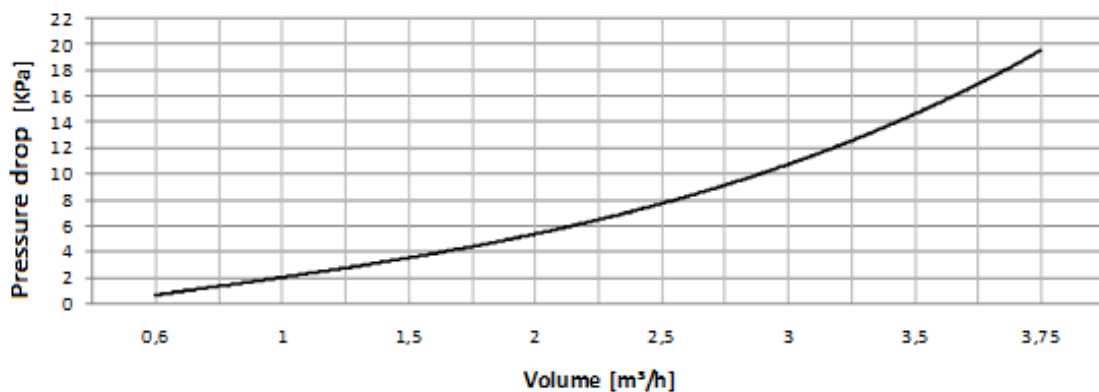

10.5 Circuit water quality

The composition and quality of the water in the system has a direct effect on the performance of the entire system and the lifetime of the heat pump.

For the initial charging and backfill of the system, usually normal tap water with a pH value of 7-8 can be used as long as the water is not highly corrosive (chloride content > 150 mg/l) or hard (>14°dH; degree of hardness IV). A drinking water analysis can be requested from the local water supply company.

If the specific system volume is greater than 25 liters/kW heating output (e.g. through the installation of a hot water buffer storage), then the maximum permissible calcium carbonate input from the charging and backfilling water should be calculated in accordance with the VDI guideline 2035. In some cases the charging water has to be softened.

Criteria	Max. value	Effects of non-compliance
PH - Wert	7-8	Danger of corrosion in boiler parts and heating system
Degree of hardness	< 14dH	- Increased lime deposits - Reduced lifetime of boiler
Chloride content	< 150mg/l	Corrosion of alloyed materials

10.6 Glycol (%)

Glycol is used as an effective antifreeze in cooling and heating applications.

The percentage of glycol to be added to the hydraulic circuit is calculated as a function of the ambient air temperature, considering for this purpose -5 °C. Using this value as a reference, the installer must add 20% Ethylene Glycol to the hydraulic circuit.

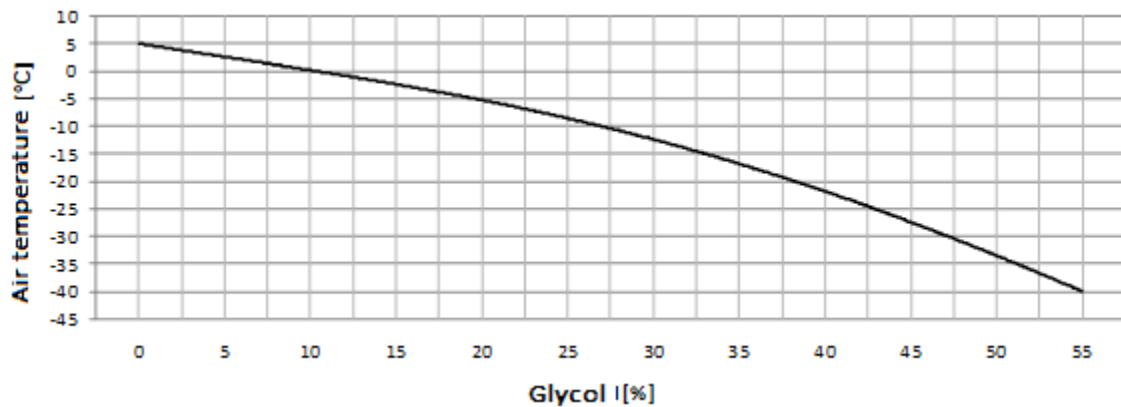

10.7 Temperature probes info

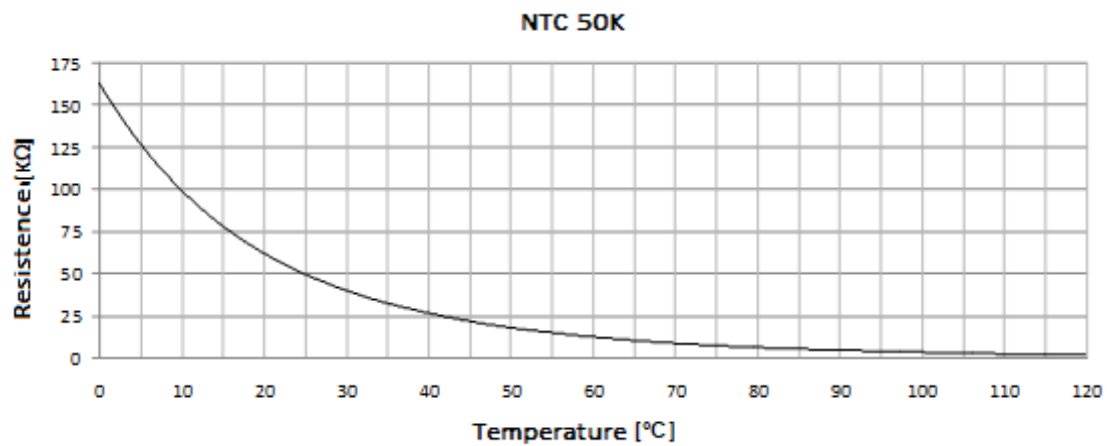
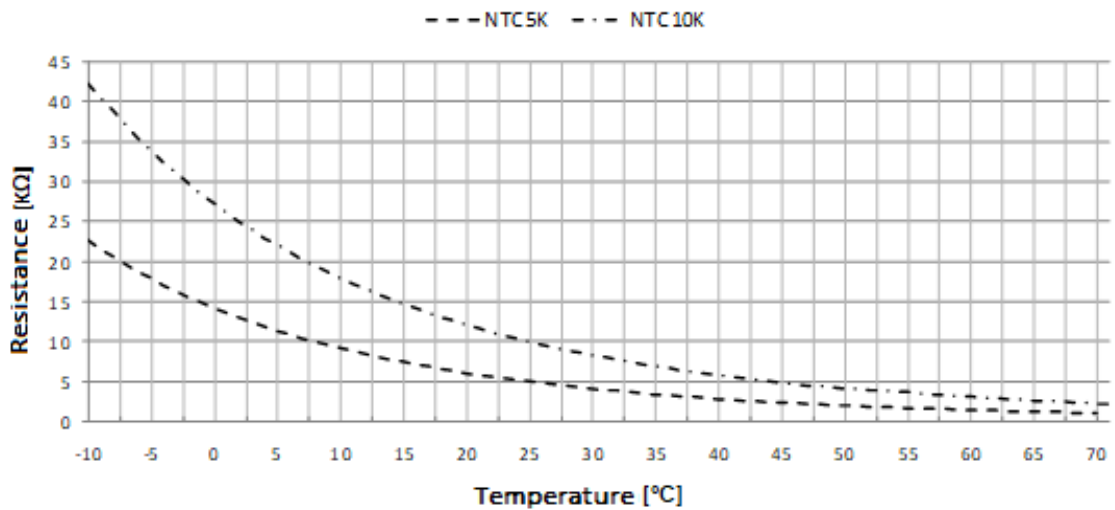

11 ELECTRICAL REQUIREMENTS

11.1 Main specifications

	Description
 WARNING	<ul style="list-style-type: none"> The installation of the electrical network must be carried out in accordance with local regulations in force and by a qualified professional. The installer must not make any kind of electrical changes to the equipment.

Before making any type of connection, check that the supply voltage matches the characteristics of the appliance.

The equipment must be connected directly to the general electrical distribution board. Dedicated protection systems must be installed for the BC (circuit breaker and differential), connecting the equipment together with others can cause voltage drops, impairing the equipment's operation. Pay attention to the losses caused by the device's power cables, the smaller the cable section area, the smaller the recommended maximum length. Make a note of the reference values for the electrical consumption of the equipment and the distance from it to the power supply and consult an electrician for advice on the diameter and type of cable to be used.

To make the electrical connection, open the side panel and connect the general power cable in the indicated places.

	Description
 WARNNING	<ul style="list-style-type: none"> The equipment must be earthed in accordance with the relevant regulations. The manufacturer is not responsible for any damage caused by the equipment's lack of earth connection or by an anomaly in the electrical supply.

11.2 Electrical main specifications/ protection devices

Model	Power source	Max. current	* cable section
Aquapura 8HT	240V/50Hz	14A	2,5mm ²
Aquapura HT 14	240V~/50Hz	25 A	4 mm ²
Aquapura HT 14 T	400V~/ 50Hz	11 A	2,5 mm ²

The section of the wires above was selected in accordance with current regulations, considering a cable distance of 10 meters.

NOTE: Follow local regulations when selecting ground wires and circuit breakers.

Select protection systems according to the following table:

Model	Power source	Max. current	CB	ELB (nº pólos/A/mA)
Auapura 8HT	240V~/50Hz	14A	20A	1F+N/20/30
Aquapura HT 14	240V~/50Hz	25 A	32 A	1F+N/ 32/ 30
Aquapura HT 14 T	400V~/ 50Hz	11A	16 A	3F+N / 16/ 30

CB - Circuit Breaker; ELB – Differential



11.3 Connection between external unit and display (user interface)



The equipment is supplied with a 12 meter cable to interconnect the outdoor unit with the display.

If the supplied cable is not long enough and the distance between the outdoor unit and the display is less than 50 meters, we recommend installing a straight-through cable.

The cable must have at least 4 conductors with a section of 0,5mm and protected with a mesh to avoid interference.

Description	
 WARNING	 The cable screen must be connected directly to the equipment ground connection.

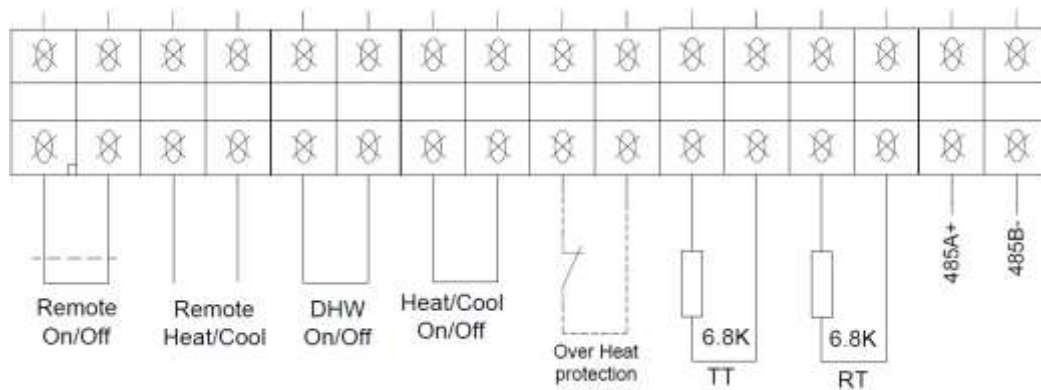

11.4 Connection terminals - Inputs

Descrição	
 WARNING	The digital inputs mentioned are dry contacts (voltage free). Do not connect (220/240V~) to the terminals, otherwise it may cause irreversible damage to the controller and loss of warranty.



*Note: The position of these terminals may vary with different models. Please check your electric scheme.

Descrição	
Terminal REMOTE ON/OFF	Switching remotely ON or OFF. <ul style="list-style-type: none"> • Contact open --- System OFF • Contact closed --- System ON
Terminal REMOTE HEAT/COOL	Switching remotely to heating or cooling mode; <ul style="list-style-type: none"> • Contact open --- Cooling mode; • Contact closed --- Heating mode
Terminal DHW ON/OFF	Switching remotely DHW function; <ul style="list-style-type: none"> • Contact open --- DHW inactive; • Contact closed --- DHW ativa
Terminal HEAT/ COOL ON/OFF	Switching remotely to turn ON or OFF the Heating or Cooling operation; <ul style="list-style-type: none"> • Contact open --- Heating or Cooling operation ON; • Contact closed --- Heating or Cooling operation OFF
Terminal TT	Connection terminal for DHW temperature probe (probe NTC10K)
Terminal 485A+/485B-	RS485- Modbus

	Description
 WARNING	<p>By default, the digital inputs are inactive</p> <p>To activate the digital inputs, contact a specialized technician or configure them according to the indicated procedure.</p>
 WARNING	 <p>ATTENTION: Use shielded cable in the connections of the digital inputs, in this way we protect the digital inputs against noise coming from the compressor.</p> <p>Not use this type of cable can lead to abnormal behavior in the operation of the equipment.</p> <p>The shielded must be connected to the equipment ground.</p>

11.5 Digital input configuration

To activate the digital inputs, proceed as follows:

1st Access the user interface, click on the “Parameter” icon and enter the password 022;



Access the “Parameter” menu;

3º In the “system” menu, change the following parameter:

Paramater	configuration
H07 – Control Mode	Display
Change to:	
H07 – Control Mode	Dry contact

11.6 Connections terminals – Outputs

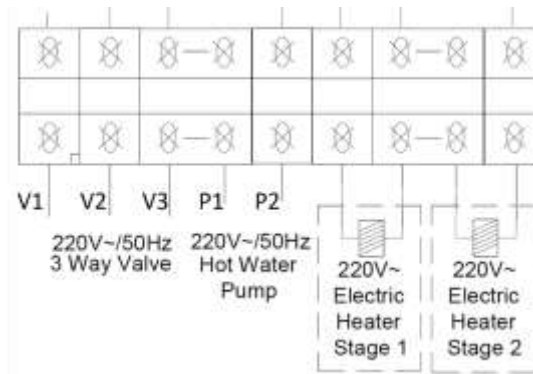

*Note: The position of these terminals may vary with different models. Please check your electric scheme.

	Descrição
Terminal V1 - Permanent phase V2 – Phase V3 - Neutral	Connection terminal for 3-way valve. Voltage polarized output (230V~) when the DHW function is active.
Terminal P1 – Neutral P2 - Phase	Connection terminal for DHW circulating pump. Voltage polarized output (230V~) when the DHW function is active.

12 ROOM THERMOSTAT INSTALLATION

The simplest way to improve and control the comfort level of your installation is through an ambient thermostat.

Your installation location is extremely important, following a series of requirements as we can see in the figure below.

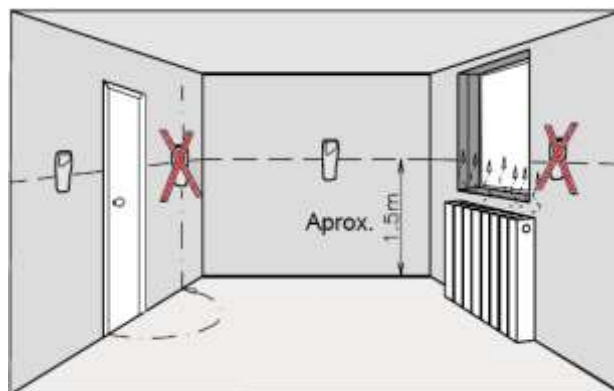

The thermostat must be installed:

- An interior wall about 1.5m from floor level;
- A place where the temperature is uniform;
- A place where have a good circulation of air around the thermostat.

The thermostat cannot be installed:

- In exterior walls;
- Near the radiators, convectors, windows, etc.;
- Behind or near the doors

	Description
 WARNING	The room thermostat contact must be free of tension. Connecting a tension on this contact will cause destruction of the controller.

13 MAIN CONTROLLER --- USER INTERFACE

13.1 User interface description



Number	Function
1	Lock screen. Click this key to lock the screen. White represents not enabled, while blue represents enabled
2	Is home icon. This Icon is shown by sliding the main interface.
3	Is tank water temperature. The machine is in hot water mode when this icon is shown; otherwise, this icon is not shown.
4	On and off. Click this key to switch ON or OFF. Blue represents ON, while white represents OFF
5	Temperature setting. Click this key to set the target temperature.
6	Outlet water temperature.
7	Target temperature.
8	Fault icon. This Icon will flash when there is an error shown up, then the display will enter Failure record interface after tapping this icon;
9	Defrosting icon. It will display in the defrosting process of the unit.
10	Timing mute icon which displays only when activated.

11	Timing switch ON/OFF of unit which displays only when activated.
12	Mode&temp.&power timer icon: This icon will be displayed when enters this timer
13	SG Ready Icon: This icon will be displayed when enters SG Ready, SG Ready includes five modes: Solar Sleep Mode, Solar Low Mode, Solar Medium Mode, Solar High Mode, Normal Mode
14	External temperature (AT)
15	System time
16	Operation mode
17	<p>Mode key:</p> <ul style="list-style-type: none"> • Domestic Hot water mode; • Heating mode; • Cooling mode; • Domestic hot water + heating mode; • Domestic hot water + cooling mode. <p>Can be selected by pressing this key.</p>

13.2 Unlock screen

Click the lock screen key again while the screen has been locked, pop-up keyboard is shown as following:

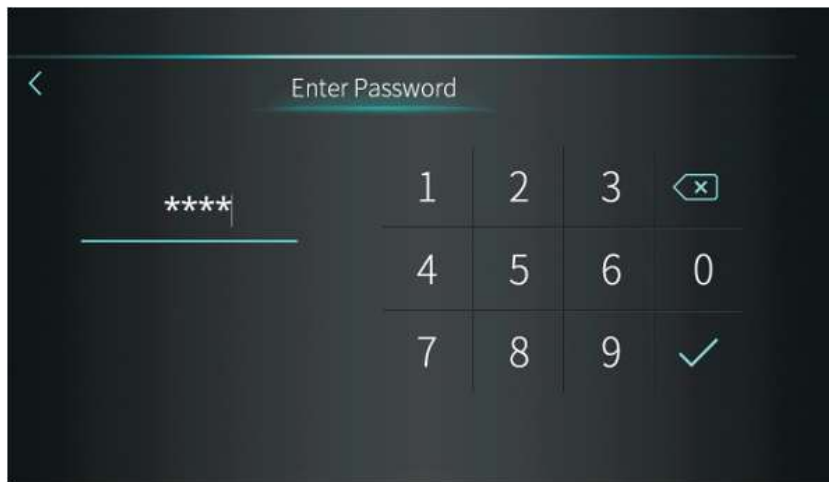

Input the password of 22 or 022, click the enter key and the screen will be unlocked.

13.3 Operation mode switch

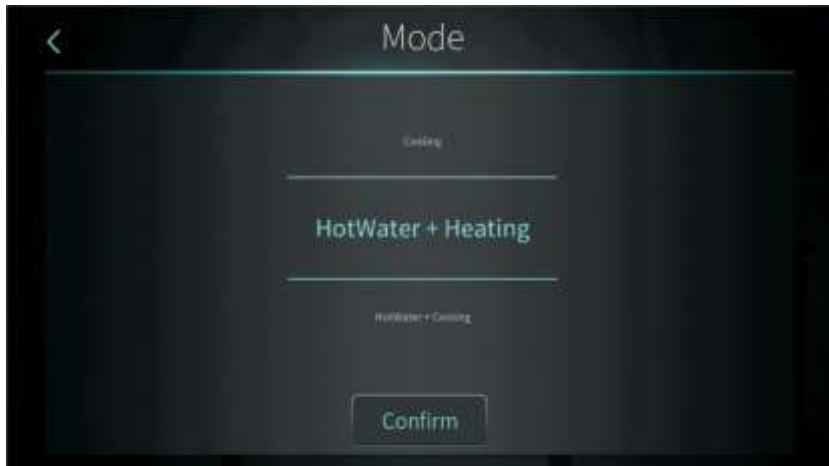

There are five modes can be selected after sliding the mode icon.

Operation mode	Description
“Hot water”	Domestic hot water mode
“Heating”	Heating mode
“Cooling”	Cooling mode
“Hot water + Heating”	Domestic hot water + Heating mode
“Hot water + Cooling”	Domestic hot water + Cooling mode

	Description
 WARNING	Domestic hot water mode has priority

13.4 Setting target temperature

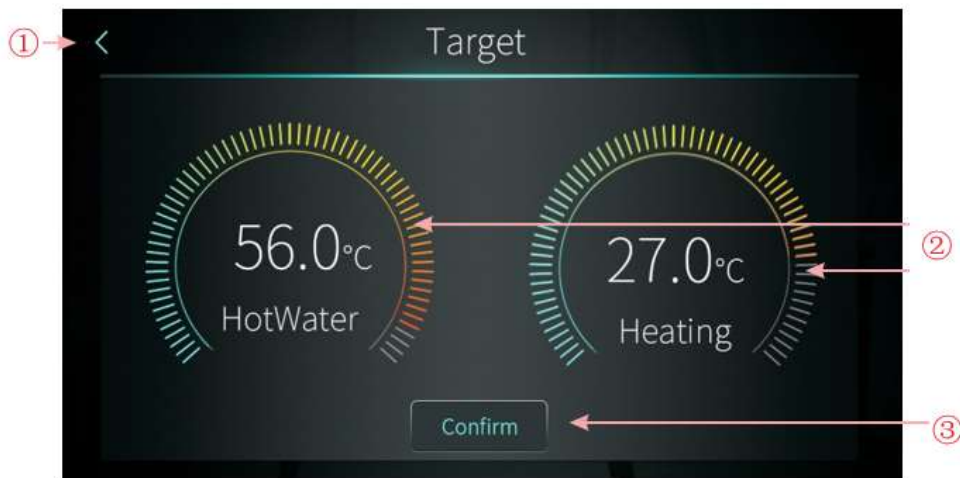

Take hot water + heating mode for example:

- (1) Tapping ①, the wire controller back to main interface;
- (2) Sliding ②, the target temperature can be adjusted in the clockwise or counter clock wise direction;
- (3) Tapping ③ the target temperature can be saved.

13.5 Setting interface display and function

Swipe from right to left on the main interface to enter the function setting interface, and swipe from left to right on the function setting interface to return to the main interface. The function setting interface is shown in the figure below.

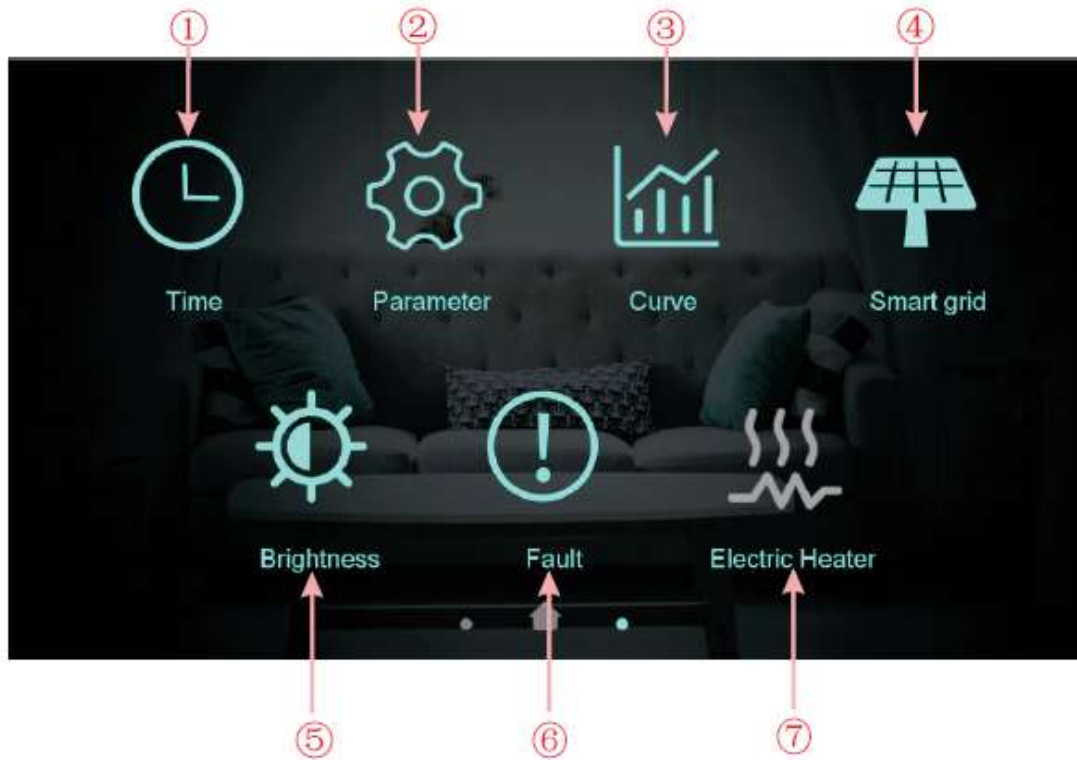

	Descrição
1	Time setting. Click this key to set the time function.
2	Factory parameter. Click the key and enter the password to enter the factory parameter settings and status parameters interface.
3	Curve key. Click this key to view the temperature curve.
4	Smart grid(SG READY) function options and control
5	Adjust brightness. Click this button to adjust screen brightness
6	Fault. Click to view fault history
7	Electric heating. When activate electric heating function, the color of the icon will turn blue, otherwise it will turn white.

13.6 Time setting



Num.	Description
1	System time setting
2	Mute timer
3	Click to set warm water pump timed cycle, hide the icon when H40=0/2, show the icon when H40=1
4	Click to set timed mute, hide the icon when H22=0, show the icon when H22=1

13.6.1 System time setting



When entering the page of system time setting, the system time will be initialized to the time at the moment when the system time setting button is pressed, and you can adjust the time by sliding up and down.

Note: The time format is displayed as: month-day-year hour: minute: second

13.6.2 Mute timer setting



Num.	Descrição
1	Whether enable the mute timer ON/ OFF function key color: Enable - Blue ON / Disable: Gray OFF
2	The mute timer ON/ OFF setting point. Select from 00:00 to 23:59
3	The status of mute timer: key color: Enable - Blue ON / Disable: Gray OFF

13.6.3 Power timer setting



Num.	Description
1	Timing switch function on. Clicking the button, when the font color is blue, the timing switch is on.
2	Week setting. Set the day of the week to activate the timing switch
3	Time period setting. Set the time to turn on and the time to turn off
4	Turn page. A total of 6 timing switch time periods can be set which can be selected by turning the page

13.6.4 Warm water circulation control setting

Note: To activate this function you need to set the parameter H40=1

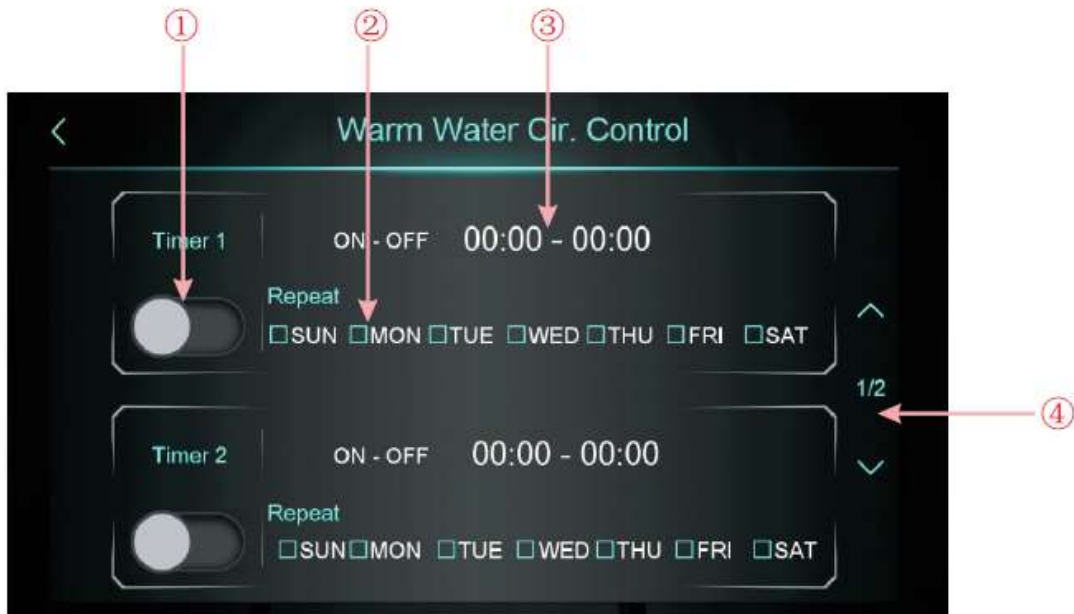

Num.	Description
1	Slider to activate the current time setting(ON – Blue icon/OFF – Grey icon)
2	Set week day for the timer
3	Set the time of day, hour a minute, that you want this timer to activate

4	Use the arrows to check the timers on all the pages. 3 different working periods can be set this way.
----------	---

13.7 Temperature curve

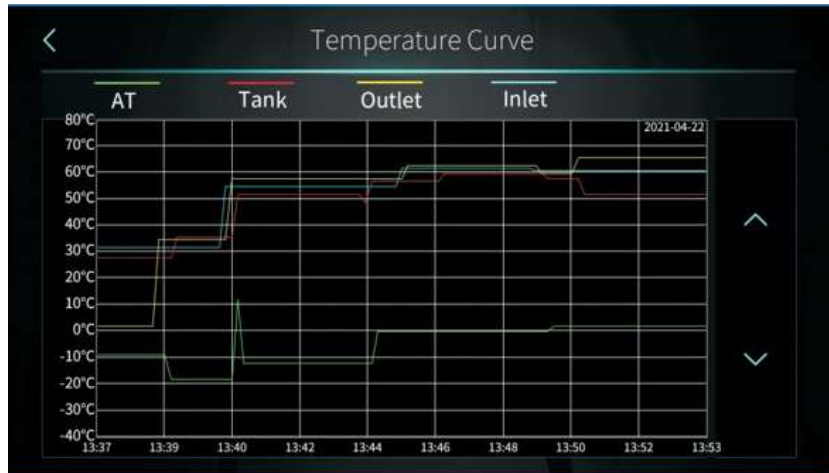

This curve function records the water inlet temperature, water outlet temperature, tank water temperature and ambient temperature;
 Temperature data is collected and saved every five minutes. Timekeeping is made from the latest data saving, if the power is disrupted when the time is less than five minutes, the data during such period will not be saved;
 Only curve for power-on status is recorded, and that for power-off will not be saved;
 The value of the abscissa indicates the time from the point on the curve to the current time point.
 The rightmost point on the first page is the latest temperature record;
 Temperature curve record is provided with power-down memory function.

13.8 Smart Grid



Num.	Description
1	Select this icon to check the state of the SG ready function
2	Select this icon to set timers for the mode and temperature of the SG ready function

This function can be activated by changing the parameter Z01=1/2. If Z01=0, this function is deactivated.

To control this function, two dry contacts can be used(SG1 and SG2) or just one dry contact(SG2). These contacts are signaled on the electric connections of the heat pump.

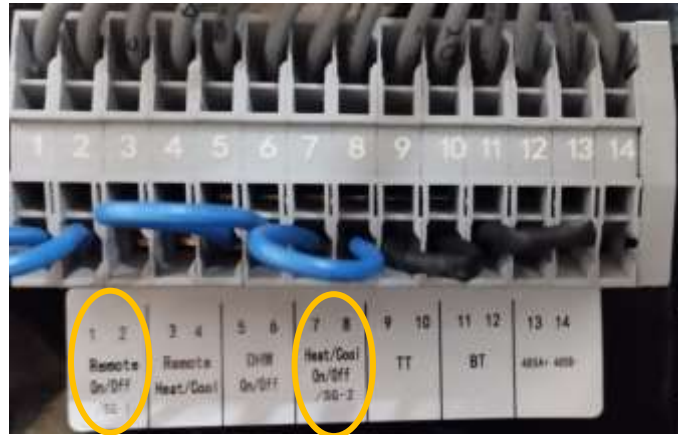

13.8.1 Parameter Z01=1

When only one dry contact is used, the display will show:

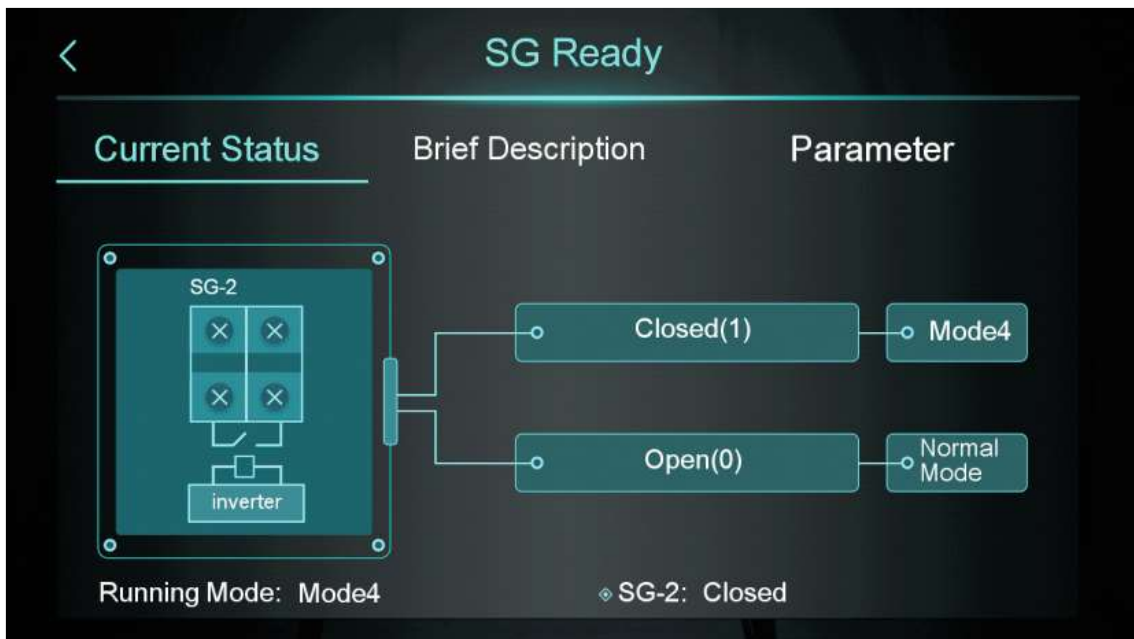

Select the button "Brief description" to check the various available modes of this function.

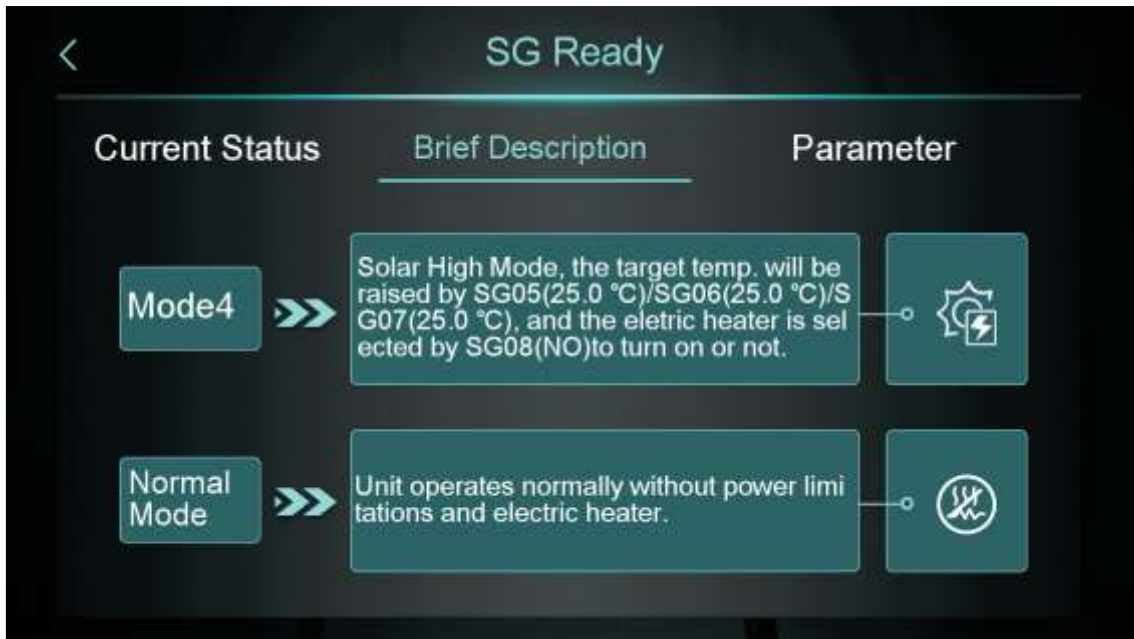

Select the button “parameter” with the installer password and access the control of the various modes of the SG ready function.



13.8.2 Parameter Z01=2

It is possible to use two dry contacts allowing thus to define 4 different modes of the SG ready function instead of 2. Its possible to define then the functioning of the heat pump according to the energy produced by the solar panels (High, Medium, Low).

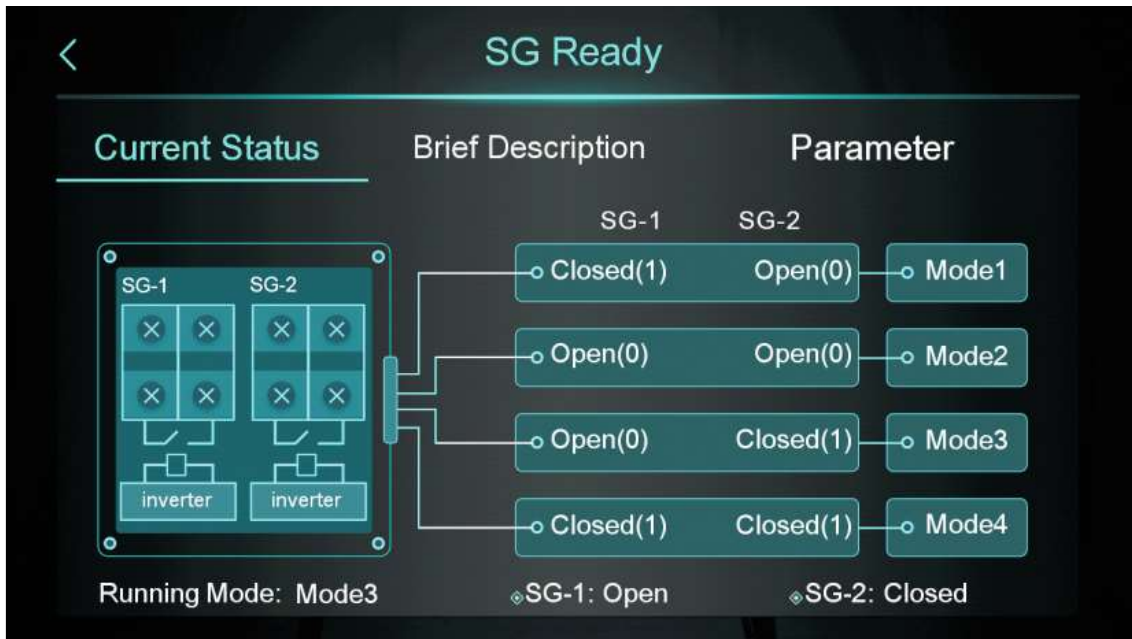

13.9 Color display calibration

The middle display bar can be dragged or clicked to adjust the brightness of the screen, with power-down memory.

Press the back key to return to the previous level and save the brightness setting value.

The screen has the function of automatic on and off, if there is no operation for 30s, the screen will enter the half-time screen state.

If there is no operation for another 5 minutes (a consecutive 5 minutes), the screen will enter the screen state.

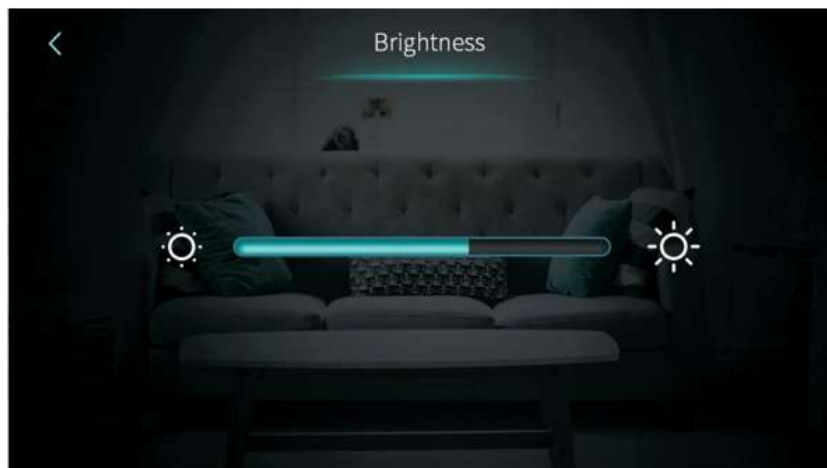

13.10 Electric Heating

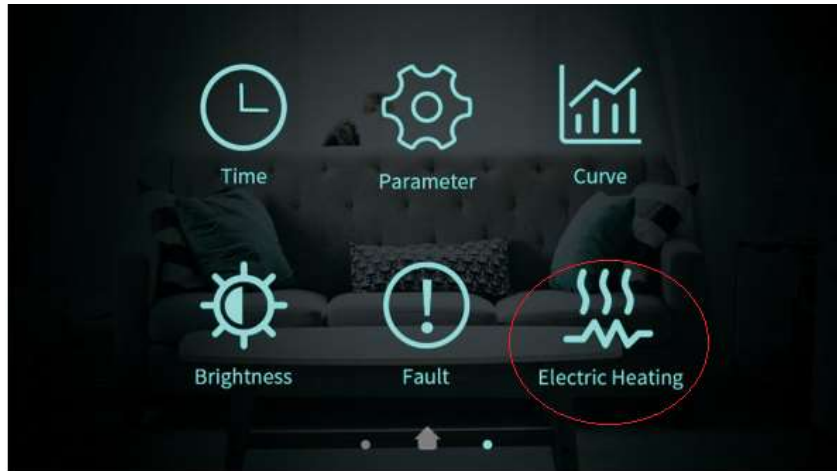

In heating operating mode, tap the “Electric Heating” icon to activate/deactivate the backup resistor (blue resistor icon active/ gray resistor icon deactivates)

Note: Resistance is not an integral part of the equipment. Its installation will have to be done separately.

13.11 Status interface display

Swipe from left to right on the main interface to enter the status interface, and swipe from right to left on the status interface to return to the main interface.

The status interface is shown in the figure below.



13.12 Fault list

Click the alarm icon on the main interface to access the following interface:



Num.	Descrição
1	Fault code
2	Fault description and date/ time
3	Clear all fault records;
4	Number of pages with fault records.

13.13 Multizone control function

This unit allows the control multiple zones of heating when the machine is operating on the DWH + heating mode. To activate this function, access the installation parameters and set the parameter Z01 to a value between 1 and 9 activating one of the modes of this function. To access this function, after it is activated, access the main screen and select the text "Heating Multi-Zone control".

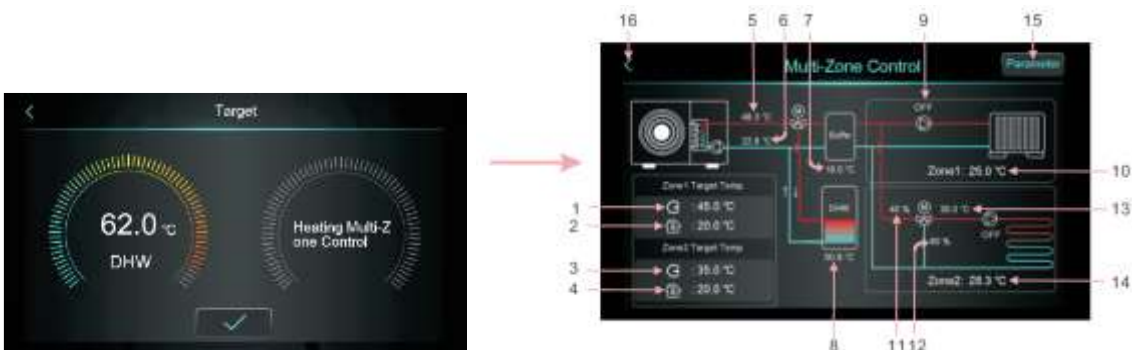

Item	Description
1	Display target outlet temperature in zone 1/target outlet water temperature after compensation
2	Display room target temperature in zone 1, when Z01=4/5/6/7/8/9,it displays "/"
3	Display target outlet temperature in zone 2/target outlet water temperature after compensation
4	Display room target temperature in zone 2, when Z01=4/5/6/7/8/9,it displays "/"
5	Outlet water temperature

6	Inlet water temperature
7	Buffer tank temperature when parameter H25=buffer tank control and “—” when H25 is different from buffer tank control
8	Tank temperature
9	When pump 1 turns on, it shows “ON” otherwise it shows “OFF”
10	Room temperature of zone 1. When Z01=4/5/6/7/8/9, it means the unit is connected to the thermostat.
11	Mixing valve of zone 2 opening percentage
12	100-mixing valve of zone 2 opening percentage
13	Mixed water temperature of zone 2
14	Room temperature of zone 2. When Z01=4/5/6/7/8/9, it means the unit is connected to the thermostat.
15	Selecting this icon and inserting the installer password will show the parameters of the SG ready functions
16	Select to return to the main screen

13.13.1 Zone 1 setpoint interface

Click “ : 45.0 °C
: 20.0 °C” to enter the target temperature in zone 1:



Icon	Description
1	Outlet temperature setpoint of zone 1
2	Room target temperature of zone 1
3	Select to check the weather compensation curve. If this function is disabled it will show “disabled”

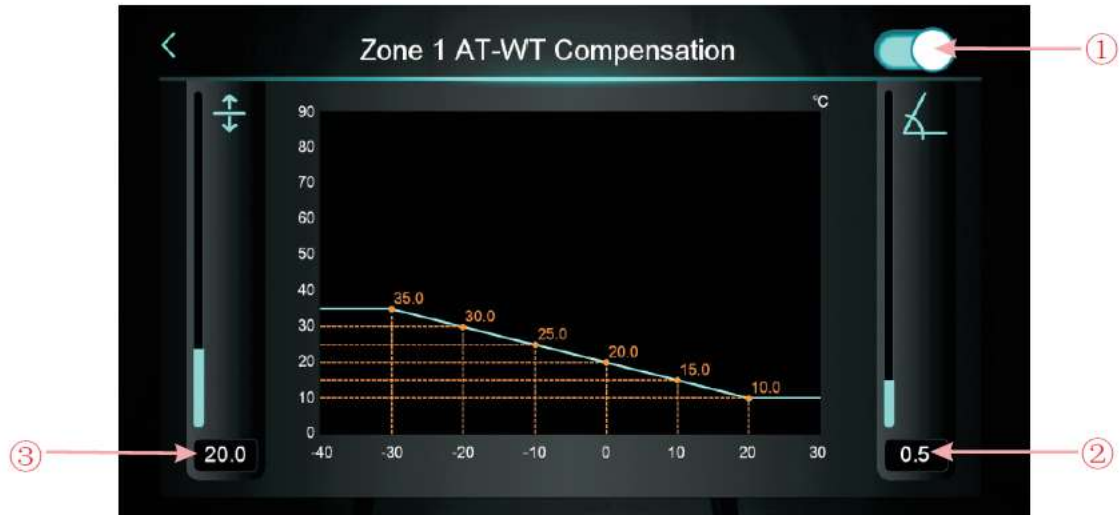

Icon	Description
1	Enable weather compensation button
2	Set the slop of the curve
3	Set the offset of the curve

13.13.2 Zone 1 setpoint interface

Selecionando o ícone da zona 2  é possível aceder aos mesmos parâmetros apresentados anteriormente na zona 1.

13.13.3 Zone control modes

When Z01=0 this function is disabled,
 When Z01=1/4/7, zone 1 is activated and zone 2 disabled
 When Z01=2/5/8, zone 2 is activated and zone 1 disabled
 When Z01=3/6/9, both zone are activated

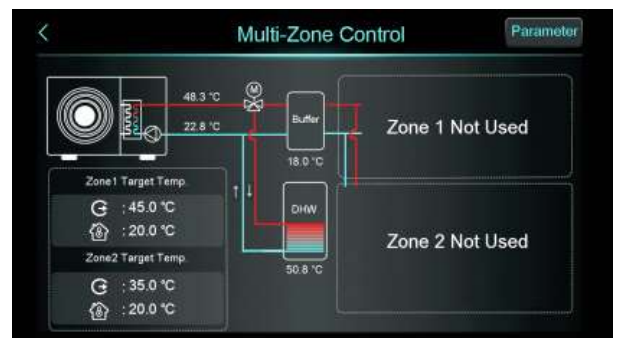
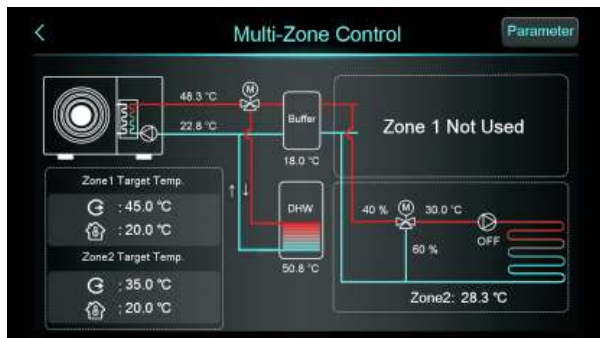

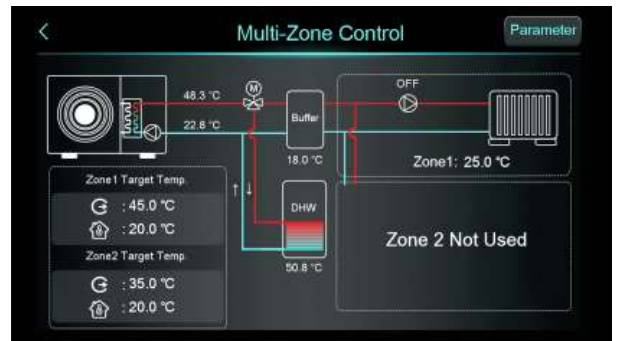
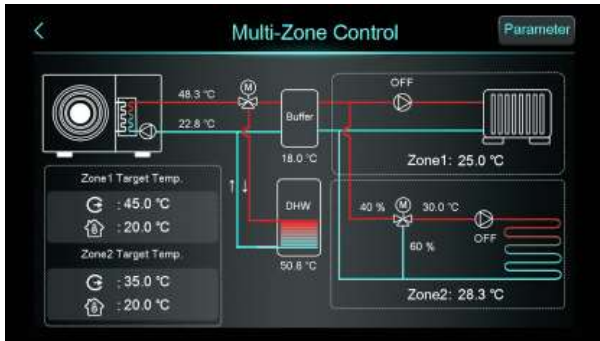

14 MAIN CONTROLLER –INSTALLER INTERFACE

To access the user interface, click on the “Parameter” icon and enter the password 022.



After entering the password, you will have access to the following menu:



“ICON”	Description
Client Parameters	Installer parameters
Defrosting	Force defrost cycle
(AT) Compensation	Ambient temperature compensation

State	Status of the main outputs of the equipment (compressor, fan, etc.)
About	Software version
Manual load control	Activate each of the units components manually

14.1 Installer parameters

	Description	State / configuration
"System"	H05 – Enable Cooling Function	YES
	H07 – Control Mode	Display
	H10 – Unit Address	1
	H18 – Electric heater	Stage 3
	H20 – 3-way valve polarity	ON for DHW ON – output (230Vac) OFF – output (0V).
	H21 – Temperature Unit	°C
	H22 – Enable silent mode	YES
	H25 – Temp. Control Selection	Outlet Water Temp.
	H28 – Heating/Cooling and Hot Water Function Enabled	Yes
	H30 – Indoor Unit Type	No
	H32 – Force Switch Mode Time	120 min
	H36 – Enable Positive Weather Compensation	No
	H37 – DHW Temp. Sourcing	DHW Tank Sensor
	H38 – Language	English
	H40 – External pump selection	0
H43 – Normal/Eco	Normal	
"Protect"	A04 – Antifreeze temp	4°C
	A23 – Min. Outlet Water Temp. Protect	5°C
	A27 – Temp. Diff. of Limiting Frequency	7°C
	A28 – Temp. Diff. Between Outlet and DHW Temp.	7°C
	A31 – Electric heater on AT	7°C
	A32 – Electric heater delays comp. On time	30 min
	A33 – Electric heater opening temp. diff	2°C
	A34 – Crank preheating Time	0 min
	A35 – Electric heater OFF temp. diff	0°C
"Defrost"	D03 – Interval Time Between Defrosting Cycles	45 min
	D17 – Coil Temp. of Exit Defrosting	13° C
	D19 – Max. Defrosting Time	8 min
	D24 – Defrosting Heating Source in Heating/DHW Mode	Heating Circuit
	D26 – Enable defrosting communication in cascade	NO

"Temp"	R01 – DWH Target Temp.	52°C
	R02 – Heating Target Temp.	55°C
	R03 – Cooling Target Temp.	7°C
	R04 – Temp. Diff. for Power-on in Heating	5°C
	R05 – Temp. Diff. for Standby in Heating	1°C
	R06 – Temp. Diff. for Power in Cooling	5°C
	R07 – Temp. Diff. for Standby in Cooling	1°C
	R16 – Temp. Diff. for Power on in DWH	5°C
	R17 – Temp. Diff. for Standby in DWH	2°C
	R35 – Location of Electric Heater	NO
	R70 – Target Room Temp.	20°C
	R71 – Room Temp. Diff. for Power on in Heating	20°C
	R72 – Room Temp. Diff. for Standby in Heating	0.5°C
	R73 – Room Temp. Diff. for Power on in Cooling	0.5°C
R74 – Room Temp. Diff. for Standby in Cooling	0.5°C	
"Pump"	P01 – Main Circulation Pump Operation Mode	Interval
	P05 – DHW Pump Operation Mode	Interval
	P06 – Main Circulation Pump Manual Control	NO
	P09 – Circulation Pump Protection Period	0 Days
"Disinfection"	G01 – Disinfection Water Temp.	63°C
	G02 – Time Duration of Disinfection	0 min
	G03 – Disinfection Starting Time	1 H
	G04 – Interval Period of Disinfection	30 days
	G05 – Enable Disinfection	Yes
Zone	Z01 – Enable multi zone control	0

	Description
 WARNING	Changing settings/parameters without consulting a specialized technician may cause malfunction or irreversible damage to the equipment.

14.2 Compensation curve - Outdoor temperature Vs setpoint

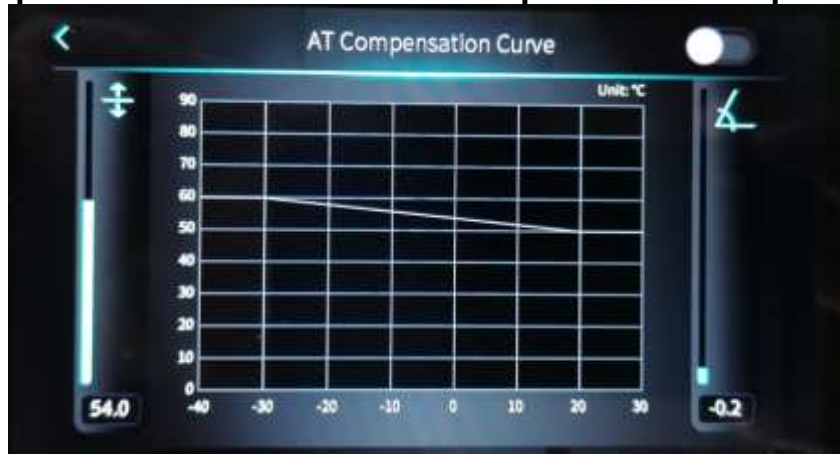

When activating the compensation function for outdoor temperature Vs flow water temperature for the central heating circuit, take into account that the setpoint will be adjusted as a function of the temperature defined in the graph.

Vertical axis - Impulse water temperature

Horizontal axis - Outdoor temperature

14.3 Output/ input state of digital / analogic contacts

	Load	Switch	Temp
001	Compressor	ON	
005	Main Circulation Pump	ON	^
006	Domestic Hot Water Pump	OFF	1/3
007	Four-way-valve	OFF	v
008	Stage 1	OFF	

In this interface, you can check the status of the main equipment variables, such as: compressor status, water pump, 3-way valve, flow switch, pressure switches, temperature values, pressure values, current consumed by the compressor, etc.

14.4 Info of software version



14.5 Manual testing

The unit allows the activation of each of its components at a time to check if they are working properly helping with the installation of the machine. This function can be used only when the machine is turned off.

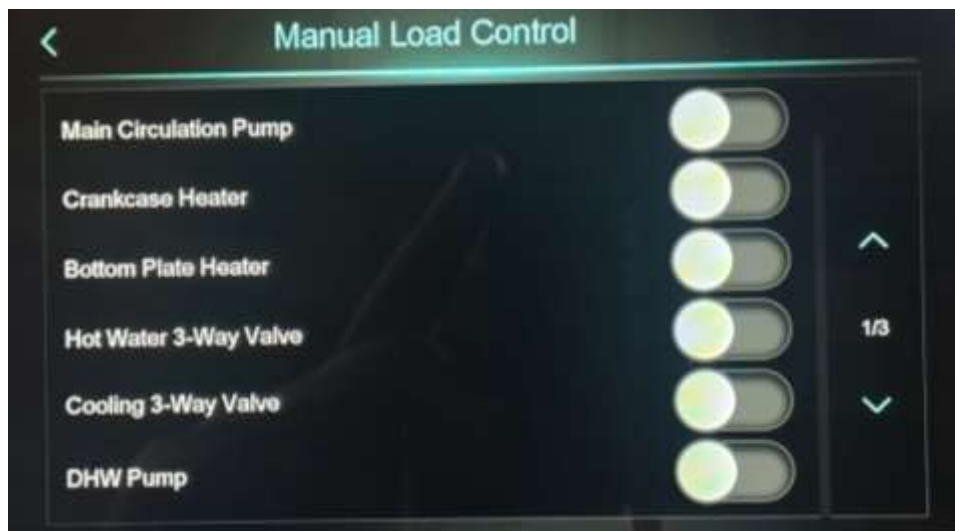

15 ALARM

15.1 Alarm – Electronic control fault table

Protect/fault	Fault display	Reason	Elimination methods
Standby	Non		
Normal boot	Non		
Inlet Temp Sensor Fault	P01	The temp. Sensor is broken or short circuit	Check or change the temp. Sensor
Outlet Temp Sensor Fault	P02	The temp. Sensor is broken or short circuit	Check or change the temp. Sensor
Water Tank Temp Sensor	P03	The temp. Sensor is broken or short circuit	Check or change the temp. Sensor
AT Sensor Fault	P04	The temp. Sensor is broken or short circuit	Check or change the temp. Sensor
Syst1: Coil temp Sensor	P153	The temp. Sensor is broken or short circuit	Check or change the temp. Sensor
Syst1: Suction temp Sensor	P17	The temp. Sensor is broken or short circuit	Check or change the temp. Sensor
Syst1: Exhaust temp. Sensor	P181	The temp. Sensor is broken or short circuit	Check or change the temp. Sensor
Syst1: Exhaust Overtemp	P182	The compressor is overload	Check whether the system of the compressor running normally
Syst1: Pressure Sensor Fault	PP11	The pressure Sensor is broken or short circuit	Check or change the pressure Sensor or pressure
Syst1: Inlet Sensor (EVI)	P101	The temp. Sensor is broken or short circuit	Check or change the temp. Sensor
Syst1: Outlet Sensor(EVI)	P102	The temp. Sensor is broken or short circuit	Check or change the temp. Sensor
Low AT Protection	TP	The ambient temp. is low	Check the ambient temp value
Flow Switch Protection	E032	No water/little water in water system	Check the pipe water flow and water pump
Aux Superheat Protection	E04	The electric-heater protection switch is broken	Check to see whether the electric heater has been running under the temperature over 150 for a long time
Room Temp Sensor Fault	P42	The temp. Sensor is broken or short circuit	Check or change the temp. Sensor
Communication Fault	E08	Communication failure between wire controller and mainboard	Check the wire connection between remote wire controller and main board
Communication Fault (speed control module1)	E081	Speed control module and main board communication fail	Check the communication connection
Syst1: HP Protection	E11	The high-pressure switch is broken	Check the pressure switch and cold circuit
Syst1: LP Protection	E12	The low-pressure switch is broken	Check the pressure switch and cold circuit

USER AND INSTALLATION MANUAL

Syst1: Antifreeze	E171	Use side water system temp. is low	Check the water temp. or change the temp. Sensor. Check the pipe water flow and whether water system is jammed or not
Prim Anti-freezing protection	E19	The ambient temp. is low	Check the ambient temp value
Secondary Anti-freezing protection	E29	The ambient temp. is low	Check the ambient temp value
Fan Motor 1 Fault	F031	1. Motor is in locked-rotor state 2. The wire connection between DC-fan motor module and fan motor is in bad contact	Change a new fan motor. Check the wire connection and make sure they are in good contact
Fan Motor 2 Fault	F032	1. Motor is in locked-rotor state 2. The wire connection between DC-fan motor module and fan motor is in bad contact	Change a new fan motor. Check the wire connection and make sure they are in good contact
Syst1:Antifreeze Sensor1	P191	The temp. Sensor is broken or short circuit	Check or change the temp. Sensor
Compressor Overcurrent Shutdown Fault	E051	The compressor is overload	Check whether the system of the compressor running normally
Outlet Water Over temp.	E065	No water/little water in water system	Check the pipe water flow and water pump
Outlet Water Low temp.	E071	No water/little water in water system	Check the pipe water flow and water pump
The Wire Controller Does Not Match the Mainboard	E084	The wire controller software is not matching with mainboard software	Check the wire control software number and the mainboard software number
Communication Fault (speed control module2)	E082	Speed control module and main board communication fail	Check the communication connection
Fan Motor1 Overload Protection	E103	The fan motor is overload	Check whether the fan motor running normally
Fan Motor2 Overload Protection	E203	The fan motor is overload	Check whether the fan motor running normally
Inlet Water Temp Sensor Fault of Air-Conditioning	P013	The temp. Sensor is broken or short circuit	Check or change the temp. Sensor
Outlet Water Temp Sensor Fault of Air-Conditioning	P023	The temp. Sensor is broken or short circuit	Check or change the temp. Sensor
Outlet Water Temp Sensor Fault of Water mixer	P02a	The temp. Sensor is broken or short circuit	Check or change the temp. Sensor
Inlet Water Temp Sensor Fault of Hot Water	P018	The temp. Sensor is broken or short circuit	Check or change the temp. Sensor
Outlet Water Temp Sensor Fault of Hot Water	P028	The temp. Sensor is broken or short circuit	Check or change the temp. Sensor

Communication Fault with Hydraulic Module	E08c	Hydraulic Module and main board communication fail	Check the communication connection
Distributor Tube Temp Sensor Fault	P152	The temp. Sensor is broken or short circuit	Check or change the temp. Sensor
Excess Water Temp Diff Prot.	E06	Water flow is not enough and low differential pressure	Check the pipe water flow and whether water system is jammed or not

15.2 Alarm – Frequency conversion board fault table

Protect/fault	Fault display	Reason	Elimination methods
IPM Overcurrent Shutdown Fault	F00	IPM Input current is large	Check and adjust the current measurement
Compressor Activation Failure	F01	Lack of phase, step or drive hardware damage	Check the measuring voltage check frequency conversion board hardware
PFC Fault	F03	The PFC circuit protection	Check the PFC switch tube short circuit or not
DC Bus Overload	F05	DC bus voltage > Dc bus Overload-voltage protection value	Check the input voltage measurement
DC Bus Underload	F06	DC bus voltage < Dc bus Underload-voltage protection value	Check the input voltage measurement
AC Input Underload	F07	The input voltage is low, causing the input current is low	Check the input voltage measurement
AC Input Overload	F08	The input voltage is too high, more than outage protection current RMS	Check the input voltage measurement
Input voltage Sample Fault	F09	The input voltage sampling fault	Check and adjust the current measurement
Comm. Err DSP-PFC	F10	DSP and PFC connect fault	Check the communication connection
Communication Fault (DSP)	F11	DSP and Inverter board communication failure	Check the communication connection
Communication Fault (Inverter Board)	F12	Frequency conversion board and main board communication failure	Check the communication connection
IPM Overheat Stop	F13	The IPM module is overheat	Check and adjust the current measurement
Compressor Overcurrent Shutdown Fault	E051	The compressor is overload	Check whether the system of the compressor running normally
Input voltage Lacking Phase	F15	The input voltage lost phase	Check and measure the voltage adjustment
IPM Current Sample Fault	F18	IPM sampling electricity is fault	Check and adjust the current measurement
Sensor Fault of Module/Radiator	F17	The transducer is over heat	Check and adjust the current measurement

IGBT Power Device Overheat Alarm	F20	The IGBT is overheat	Check and adjust the current measurement
Weak Magnetic Warn	F16	Compressor magnetic force is not enough	Check and adjust the current measurement
AC Input Overcurrent Alarm	F22	Input current is too large	Check and adjust the current measurement
EEPROM Error Warn	F23	MCU error	Check whether the chip is damaged Replace the chip
Destroyed EEPROM Activation Ban Alarm	F24	MCU error	Check whether the chip is damaged Replace the chip
V15V Over/Undervoltage Fault	F25	The V15V is overload or undervoltage	Check the V15V input voltage in range 13.5v~16.5v or not
IGBT Power Device Overheat Fault	F26	The IGBT is overheat	Check and adjust the current measurement
Compressor Current Frequency Reduction Alarm	F33	The Compressor Current Frequency Reduction	Check and adjust the current measurement

16 TROUBLESHOOTING



Failure	Possible causes for the failure	Solutions
BC does not work, display without information	Power supply failure: 2) Circuit breaker off; 3) Power cable not properly connected; 4) Swapped phases; 5) Blown controller fuse	1) Check the power supply. 2) Check if there is an anomaly and turn the circuit breaker back on. 3) Connect the power cord correctly. 4) Change one of the phases. 5) Check the fuse
Water pump is running with high noise or without water	1) Lack of water. in the hydraulic circuit, 2) Air in the installation 3) Valves closed 4) Dirty or clogged water filter	1) Check that there is no water leak. Fill the circuit 2) Purge the hydraulic circuit. 3) Open the valves 4) Clean the filter
Heat pump capacity is low, compressor do not stop	1) Lack of refrigerant; 2) Bad insulation on water pipe; 3) Low heat exchange rate on air side exchanger; 4) Lack of water flow	1) Check for the gas leakage and recharge the refrigerant; 2) Make good insulation on water pipe; 3) Clean the air side heat exchanger; 4) Clean the water filter
High compressor exhaust	1) Too much refrigerant; 2) Low heat exchange rate on air side exchanger.	1) Discharge the redundant gas; 2) Clean the air side heat exchanger
Low pressure problem of the system	1) Lack of refrigerant gas 2) Outside temperature too low. 3) Obstruction of the refrigerant circuit.	1) Check the gas leakage and recharge freon; 2) Replace filter or capillary; 3) Clean the water filter and discharge the air in water loop.

USER AND INSTALLATION MANUAL

Compressor do not run	<ol style="list-style-type: none"> 1) Power supply failure; 2) Compressor contactor broken; 3) Power cable loose; 4) Protection on compressor; 5) Wrong setting on return water temp. 6) Lack of water flow. 	<ol style="list-style-type: none"> 1) Check off the power supply; 2) Replace compressor contactor; 3) Tighten the power cable; 4) Check the compressor exhaust temp.; 5) Reset the return water temp.; 6) Clean the water filter and discharge the air in water loop.
High noise of compressor	<ol style="list-style-type: none"> 1) Liquid refrigerant goes into compressor 2) Compressor failure 	<ol style="list-style-type: none"> 1) Bad evaporation, check the cause for bad evaporation and get rid of this; 2) Replace the compressor;
Fan do not run	Failure on fan relay or fan motor broken	Replace the fan relay or replace fan motor.
The compressor runs but heat pump has not heating or cooling capacity	<ol style="list-style-type: none"> 1) No gas in the heat pump; 2) Heat exchanger broken; 3) Compressor failure. 	<ol style="list-style-type: none"> 1) Check system leakage and recharge 2) Refrigerant; find out the cause and replace the heat exchanger; 3) Replace compressor.
Low outlet water temperature	<ol style="list-style-type: none"> 1) Low water flow rate; 2) Low setting for the desired water temp.; 	<ol style="list-style-type: none"> 1) Clean the water filter and discharge the air in water loop. 2) Reset the desired water temperature.
Low water flow protection	<ol style="list-style-type: none"> 1) Lack of water in the system; 2) Failure on flow switch 	<ol style="list-style-type: none"> 1) Clean the water filter and discharge the air in water loop. 2) Replace the flow switch.

17 APPENDIX 1 – HYDRAULIC SCHEMES

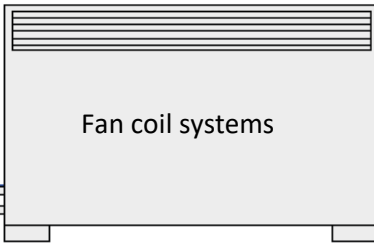
	Description
 WARNING	<ul style="list-style-type: none"> This drawing just shows the core parts and main principle of the application, there are many parts can be installed such as water pressure meters, water temperature meter, drainage etc. The hot water circuit, when implemented, has priority over the air conditioning circuit.

	Description
INFO	<p>The heat dissipation source shown in the diagrams is merely representative.</p> <p>The equipment can be installed with radiators, radiant floor systems, fan coils, etc.</p> <div style="display: flex; justify-content: space-around; align-items: center;"> <div style="text-align: center;">  <p>Fan coil systems</p> </div> <div style="text-align: center;">  <p>radiant floor systems</p> </div> </div>

17.1 Hydraulic schemes glossary

1	Shutoff valve	11	Differential bypass valve
2	Filling valve	A	Water inlet (central heating)
3	Safety valve	A1	Cold water inlet (DHW)
4	Expansion vessel	B	Central heating (radiators, floor heating or fan coils)
5	Filter	C	Hot water outlet (DHW)
6	Valve (non-return)	BT	Buffer tank
7	Water tank (DHW)	P1	Circulating pump
8	3 way valve	T1	Room thermostat
9	Automatic air vent	TT	DHW temperature probe
10	Pressure reducing valve	12	Thermostatic valve

17.2 Central Heating and Cooling

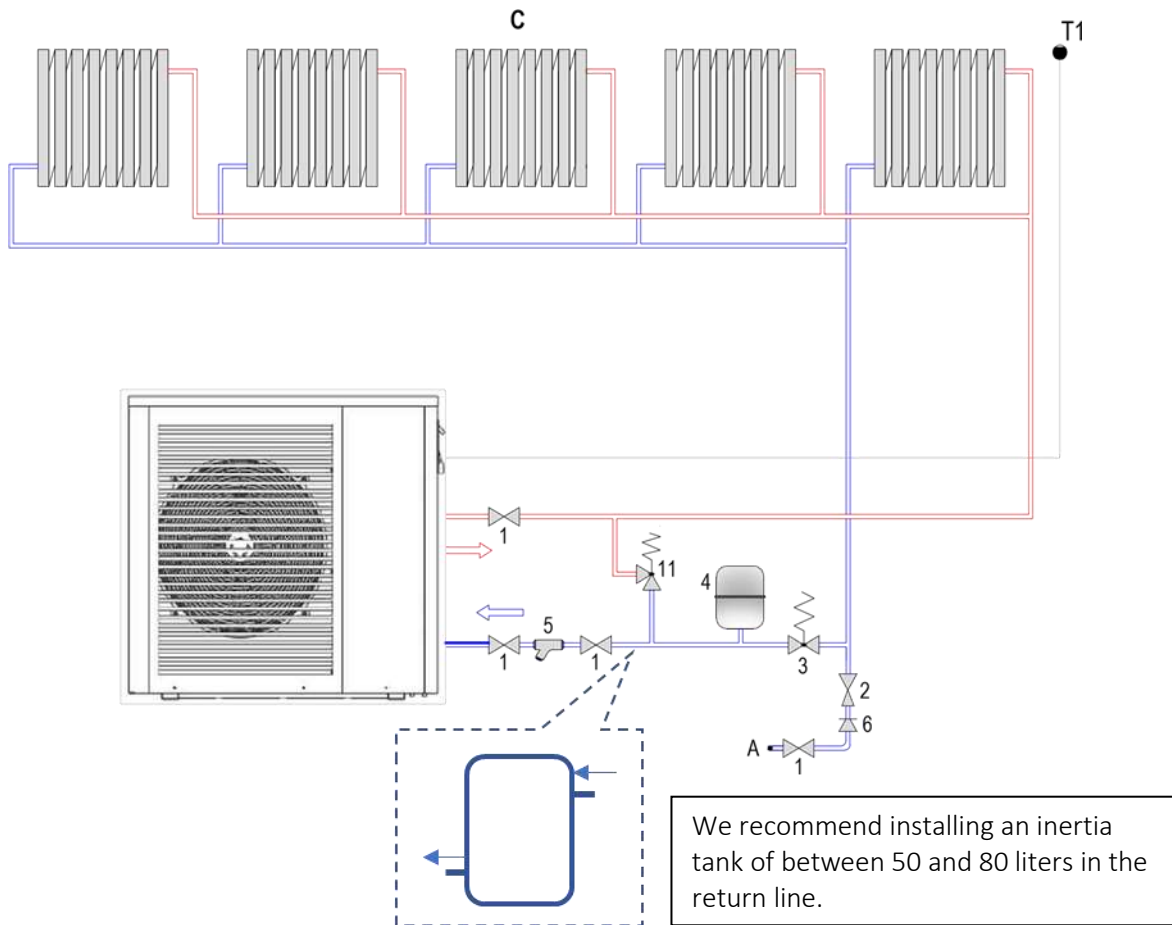

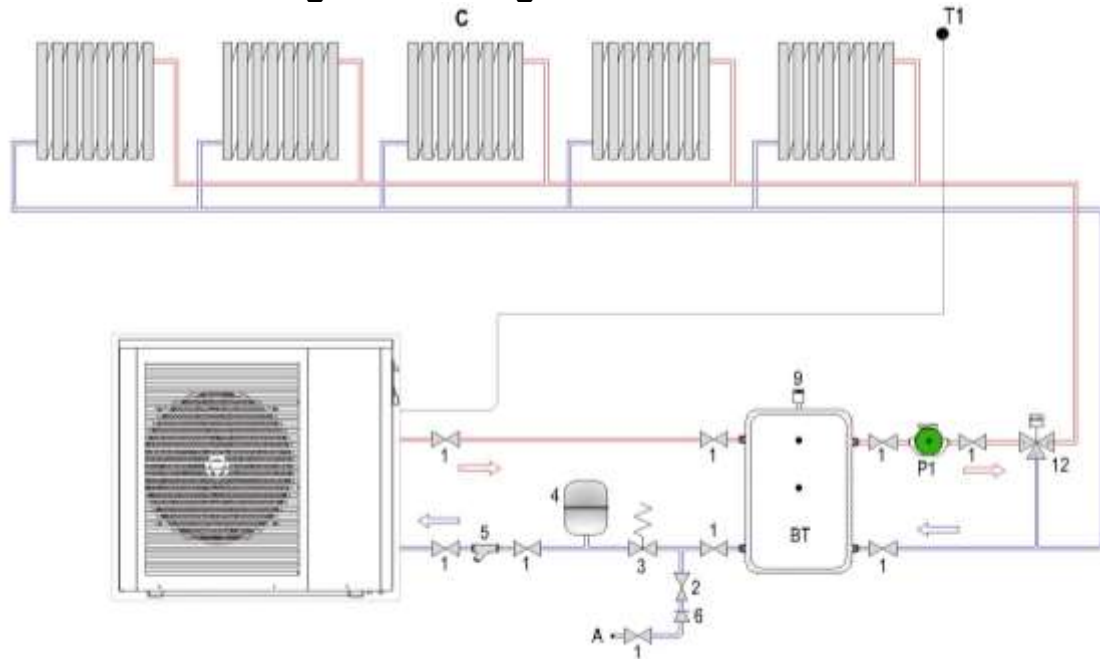

17.3 Central Heating and Cooling with buffer tank

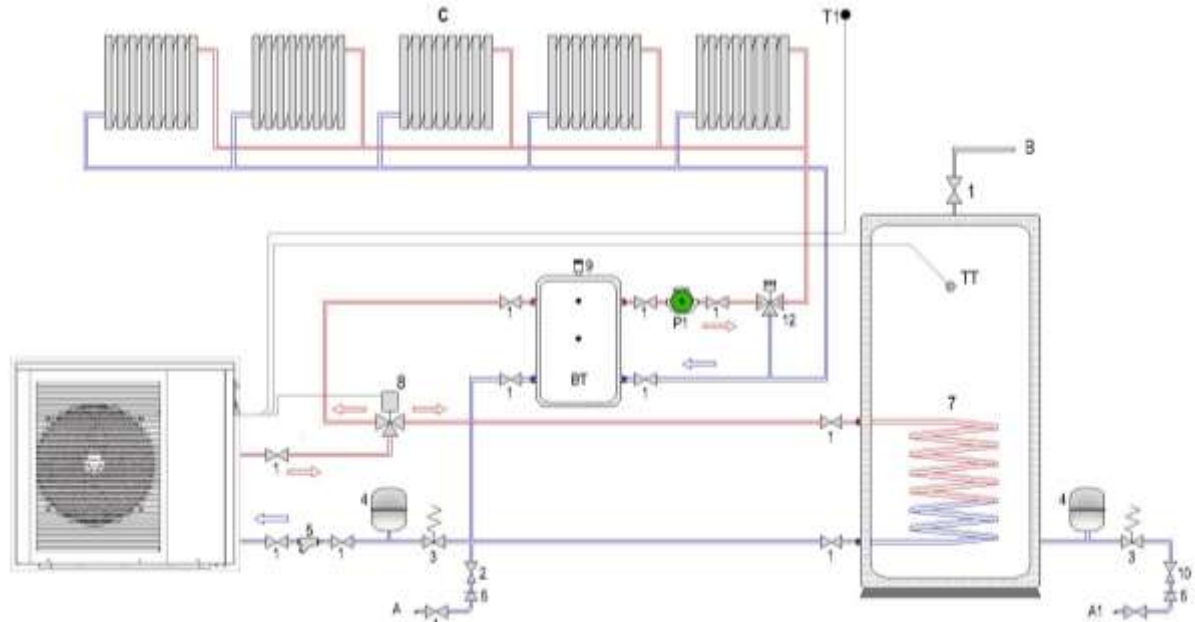

Description	
 ATTENTION	The heat pump does not control the pump “P1”, its control must be carried out separately.

17.4 Central Heating and Cooling with buffer tank + DHW



Description	
 ATTENTION	The heat pump does not control the pump “P1”, its control must be carried out separately The heat pump manages the three-way valve depending on the requested request (Central heating or DHW).

	The DHW temperature probe is provided with system. The temperature probe is located inside the installation kit
--	---

17.5 Central Heating and Cooling + DHW

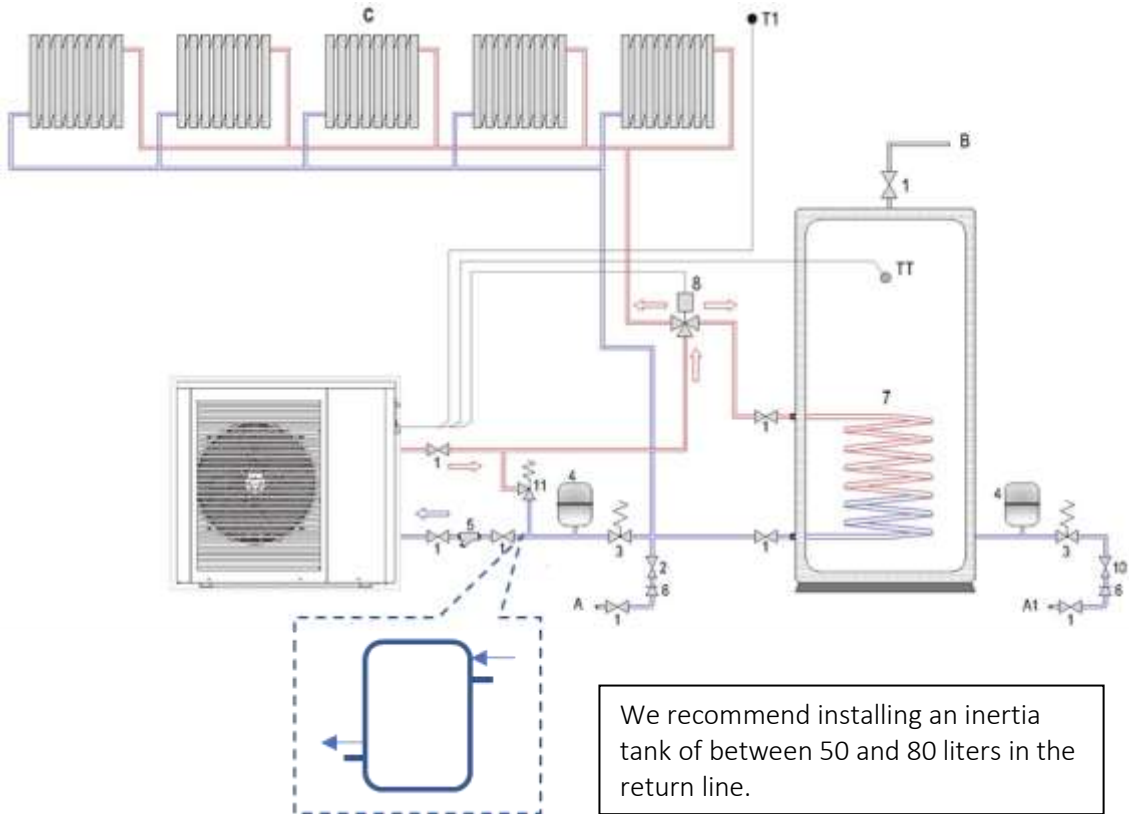

We recommend installing an inertia tank of between 50 and 80 liters in the return line.

Description	
 ATTENTION	The heat pump manages the three-way valve depending on the requested request (Central heating or DHW). The DHW temperature probe (TT) is provided with system. The temperature probe is located inside the installation kit

17.6 Domestic hot water

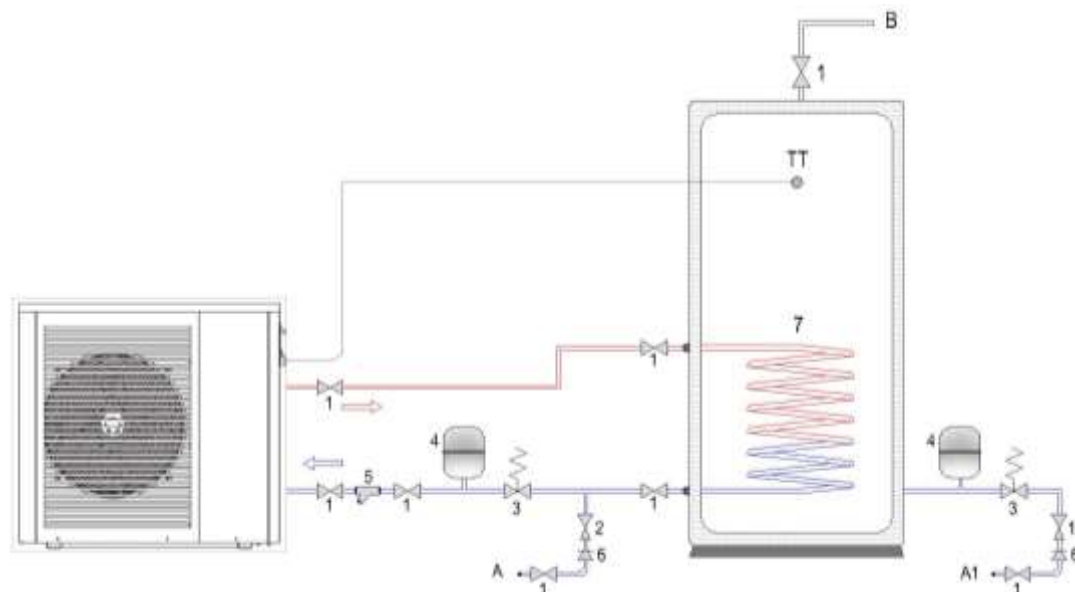

Description	
 ATTENTION	The DHW temperature probe (TT) is provided with system. The temperature probe is located inside the installation kit

18 WARRANTY

This warranty covers all defects to the confirmed materials, excluding the payment of any type of personal damage indemnity caused directly or indirectly by the materials.

The periods indicated below start from the purchase date of the apparatus, 6 months at the latest from the leaving date from our storage warehouses.

Component	Warranty period
Water Cylinder (domestic or industrial application)	3 (three) years with an extension of + 2 (two) years *
Heat pump	3 (three) years

* The warranty extension of 3 years is conditioned to the submission of:

- Warranty and Check Sheet at maximum 15 days after the installation;
- Documental evidence of the magnesium anode replacement;
- Pictures of the installation where it's shown safety group, expansion vessel, hydraulic and electrical connections.

In case of warranty, the parts replaced are property of the manufacturer.

A repair under the warranty is not reason for an extension of its term.

Warranty Exclusions

The warranty ceases to be effective when the apparatus is no longer connected, used or assembled in accordance with manufacturer instructions, or if there has been any form of intervention by unauthorized technicians, has the appearance of modifications and/or if the series number appears to have been removed or erased. The equipment should be installed by qualified technicians according to the rules in effects and/or the rules of the trade, or the instructions of our technical services. Further exclusions from warranty:

- Hot water tanks have been operating in water with the following indexes:
 - Active chlorine > 0.2 ppm;
 - Chlorides > 50 mg/l (Inox);
 - Hardness > 200 mg/l;
 - Conductibility > 600 $\mu\text{S}/\text{cm}$ (20 °C);
 - 5,5 > PH and PH > 9 (Sorensen at 20°C);
 - If one of the water parameters has a greater value than stipulated by directive 236/98 (Portugal) or equivalent standard in the costumer's country.
- Parts are subject to natural wear and tear – levers, switches, resistances, programmers, thermostats, etc;
- Breakdown due to incorrect handling, electrical discharges, flooding, humidity or by improper use of the apparatus;
- The warranty lapses if it is transferred to another owner, even if within the guarantee period;
- The warranty lapses if this certificate is incorrectly filled in, if it is violated or if it is returned after more than 15 days have passed since the purchase date of the apparatus.
- Water cylinder that are working in waters with the following indices:
 - active chlorine > 0,2 p.p.m

If you have any question about the operation and maintenance of the unit that are not addressed in this manual, or if you feel that something in the manual is unclear, please contact us.

