



BOOSTER 120 i 200 i 300 i



Esteemed Client,

We would like to thank you for your choice when you acquired an equipment for sanitary water heating.

Energie BOOSTER system will surely meet all your expectations and provide many years of comfort with maximum power saving.

Our organization dedicates much time, energy and economic resources in order to develop innovations that will promote power saving in our products.





Your choice has demonstrated your good sense and concern with power consumption, a matter that affects the environment.

We have taken on a permanent commitment to conceive innovative and efficient products so that this rational use of energy can actively contribute to the preservation of the environment and natural resources of the planet.

Keep this manual whose objective is to inform, alert and advise about the use and maintenance of this equipment.

Our services are always at your disposal. Feel free to call upon us!



Index

1	INTRO	5
1.1	Symbols.....	5
1.2	Pre-installation Information	5
1.3	Safety Information.....	6
2	SPECIFICATIONS.....	7
2.1	Components	7
2.2	Running Principle.....	7
2.3	Technical Data.....	8
3	TRANSPORT.....	9
4	INSTALLATION.....	10
4.1	Safety and Control Devices	10
4.1.1	High/Low Pressure Switch.....	10
4.1.2	Safety Thermostat.....	10
4.1.3	Temperature Probe	10
4.1.4	Expansion Vessel*)	10
4.1.5	Safety Group*)	10
4.1.6	Pressure Reducing Valve*)	10
4.2	Drain pan	11
4.3	Positioning	11
4.4	Hydraulic Installation.....	12
4.5	Installation configuration	14
4.5.1	Pump configuration	14
4.5.2	Valve configuration.....	15
4.6	Condensates.....	15
4.7	Electrical Connections	16
5	Electrical Diagram.....	17
6	CONTROL and PROGRAMMING	18
6.1	Control Panel	18
6.2	Keys (Functions).....	18
6.3	Display.....	19
6.3.1	Interface	19
6.3.2	Symbols	19
6.3.3	Symbols with Equipment Running.....	20
6.4	Start-up of the System	21
6.5	Operating Modes	21
6.5.1	 ECO Mode	22
6.5.2	 AUTO Mode	22
6.5.3	 BOOST Mode	22
6.5.4	 TCC Mode	23
6.5.5	Chrono scheduling of the heat pump.....	24
6.5.6	Chrono scheduling of the recirculation pump	25
6.5.7	Additional functions	26
6.6	Extra Modes	30
6.6.1	DISINFECT 	30

6.6.2	VACATION Mode 	30
6.7	Menu.....	30
6.8	Changing Mode.....	30
6.9	Number of Showers Available.....	30
6.10	Consultation of probe temperatures (S1, S2, S3).....	31
6.11	Source control flow	31
7	CHECKING GOOD RUNNING CONDITION	31
8	PARAMETERS DESCRIPTION.....	32
9	ERRORS	34
10	PROBE CHART.....	35
11	TROUBLESHOOTING	36
12	SYSTEM MAINTENANCE	38
12.1	General Inspection.....	38
12.2	Empty the Water Storage.....	38
12.3	Filter of Reduction Valve.....	38
12.4	Condensate circuit	38
12.5	Safety Thermostat.....	38

1 INTRO

1.1 Symbols

	<p>Every process that the supplier believes to be conducive to harmful danger and/or material damage will be signalled with a danger sign.</p> <p>To better characterize the danger, the symbol will be followed by one of these words:</p> <ul style="list-style-type: none"> • DANGER: when there is the possibility of harm to the operator and/or people in the vicinity of the equipment • WARNING: when there is the possibility of material damage to the equipment and/or attached materials.
	<p>All the information that the supplier believes to be an asset for better performance and preservation of the equipment, will be signalled together with the information sign.</p>

1.2 Pre-installation Information

 WARNING/DANGER	
<ul style="list-style-type: none"> • The electrical installation of the equipment must comply with the national regulations for electrical installations in effect. • The equipment can only work if the water heater is filled with water and properly purged; • The electrical supply is 220 – 240 V/50 Hz or 60Hz* (equipment version only designed on specific request); • The equipment must be connected to an electrical outlet with earth contact; • If the power supply cable is damaged, it must be replaced by the manufacturer, by its customer service, or by staff with similar training in order to avoid any danger. • Children must not play with the device. • Cleaning and maintenance must not be carried out by children without supervision. • According to standard EN60335-2-40: This device can be utilized by children of 8 years old or more and by people with limited physical, sensorial or mental capabilities or with lack of experience and knowledge if they are being watched or have receive instructions regarding the use of this device in a safe manner and if they understood the risks involved. • According to standard EN60335-2-21: This device can be utilized by children of 3 years old or more and by people with limited physical, sensorial or mental capabilities or with lack of experience and knowledge if they are being watched or have receive instructions regarding the use of this device in a safe manner and if they understood the risks involved. The children of ages between 3 and 8 can only operate the tap connected to the device • According to standard EN6335-2-40 + IEC60335-2-21: This device can be utilized by children and people with limited physical, sensorial or mental capabilities or with lack of experience and knowledge if they are being watched or have receive instructions regarding the use of this device in a safe manner and if they understood the risks involved. • The operating principle of this equipment is directly linked to high temperatures and pressures, so all processes that involve contact with the equipment must be prepared with care to avoid risks of burns and material projection. <p>The heating of other fluids than drinking water is not allowed.</p>	

1.3 Safety Information



Every process that the supplier believes to be conducive to harmful danger and/or material damage will be signalled with a danger sign.

To better characterize the danger, the symbol will be followed by one of these words:

- DANGER: when there is the possibility of harm to the operator and/or people in the vicinity of the equipment
- WARNING: when there is the possibility of material damage to the equipment and/or attached materials.



INFORMATION

When installing:

- The installation of heat pump equipment for heating sanitary water must be carried out by staff with suitable training and qualified for this purpose;
- The device should not be installed in places that present a risk of impact, shock or explosion;
- Keep the equipment packed until you reach the place and time of installation;
- Make sure all hydraulic couplings are watertight before connecting the equipment to the power supply.

Maintenance of the equipment:

- Equipment maintenance should be carried out by customer service, except operations of general and continuous cleaning which could/should be carried out by the user;
- Power supply to the equipment must be disconnected during maintenance operations;
- The supplier recommends at least one annual inspection to the equipment, by a qualified technician;
- Cleaning and maintenance must not be carried out by children unless they are under supervision

High pressure and temperature:

- The principle for running this equipment is directly linked to high temperature and pressure; thus, the processes that imply contact with the equipment, must be thought out with caution to prevent the risk of burns and projection of material;

Refrigerant:

- The refrigerant used in the entire process is R134a, CFC-free, non-inflammable and without harmful effects to the ozone layer;
- However, according to the law, the fluid in this equipment cannot be released into the environment;
- Handling of the fluid in the equipment must be carried out by a qualified technician.

Information for the Client:

- The Installer must inform the client about the running of the equipment, its dangers, rights and duties of the client;

2 SPECIFICATIONS

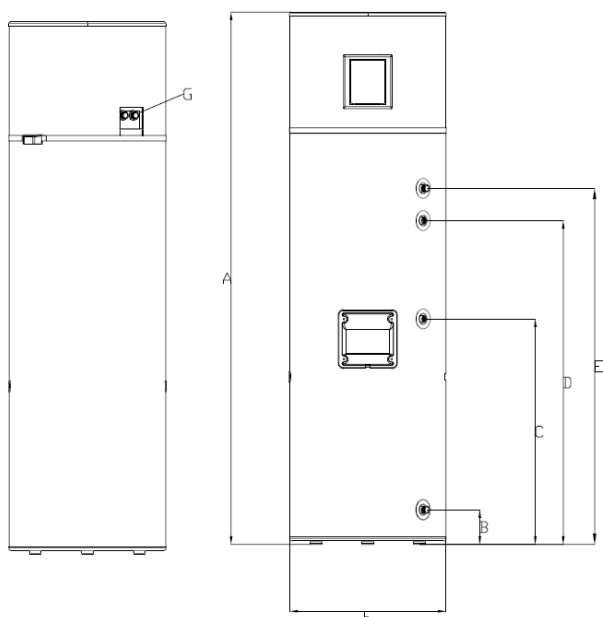

2.1 Components

The **Booster** package contains:

- Stainless steel water storage tank with electric heater.

Dimensions:

	Ø Inch.	Booster 300 mm	Description
A	-	1968	-
B	G 3/4" M	131	C – Cold Water Inlet
C	G 1/2" F	840	R - Recirculation
D	G 1/2" F	1325	PT – PT Valve
E	G 3/4" M	1477	H – Hot Water Outlet
F		Ø580	
G		3/4" M	

- A **cooling system**, at the top, retrieving heat from the heat source into the water on the tank.

2.2 Running Principle

1. The cooling fluid (R134a) is compressed in the high efficient compressor, raising its pressure and temperature;
2. In the condenser (not in direct contact with the water), the heat energy in the cooling fluid is transmitted to the water in the water storage heater;
3. The condensate fluid (high pressure) goes through the expansion valve which is responsible for reducing its pressure;

4. The fluid absorbs heat energy from the water source in plate heat exchanger;



The R134a is a HFC fluid, thus not harmful to the ozone layer. It has great chemical and thermal stability, low toxicity, non-inflammable, and is compatible with most materials.

2.3 Technical Data

	Unit	BOOSTER 300
Type of Equipment	-	Water/Water Heat Pump for DHW
DHW Capacity	L	270
Empty Weight	Kg	98
Dimensions (ø/height)	-	580/1968
Storage Water Heater Material	-	Stainless steel
Insulation	-	High-density polyurethane 50mm
Max Running Temperature	°C	80
Max Working Pressure	bar	7
Heat Loss	kWh/24h	1,01
Protection Index	-	IPX1
Power Supply	-	220-240 Vac / monophasic / 50 Hz
Absorbed Power (med / max)	W	400/700
Absorbed Power Electrical Support	W	1500
Thermal Power Supplied BC	W	1800
Max Running Current	A	3,2 + 6,8 (with backup electrical heater)
Max DHW Temperature (BC)	°C	60
Max DHW Temperature (Backup)	°C	70
Refrigerant	-/kg	R 134a / 1,2
Load Profile	-	XL
COP ^{1) / 2)}	-	4,5 / 5,19
Heating Time ^{1) / 2)}	(hh:mm)	05:57 / 07:45
Amount of Useful Water 40°C ^{1) / 2)}	L	323
Energy Efficiency Class ^{1) / 2)}	-	A++ / A+++
Energy Efficiency ^{1) / 2)}	%	188 / 220
Annual Electricity Consumption ^{1) / 2)}	kWh/year	1041 / 1227
Sound Power Level Indoor ³⁾	dB(A)	45

1) Heat source at 25° and DHW temperature from 10°C-53°C, according to EN16147 and regulation (EU) N°812/2013

2) Heat source at 35° and DHW temperature from 10°C-53°C, according to EN16147 and regulation (EU) N°812/2013

3) According with EN12102

3 TRANSPORT

 WARNING	<p>The equipment must be carried in an upright position. The equipment must be raised and lowered with extreme care, to avoid impact that could damage the material. Make sure the belts and/or transportation straps do not damage the material. Always use suitable means to transport the material (pallet lift, forklift, etc.)</p>
-----------------------------------------------------------------------------------------------------	--------------------------------------------------------------------------------------------------------------------------------------------------------------------------------------------------------------------------------------------------------------------------------------------------------------------------------------------------------------------------------------------------------

Correct transport position:





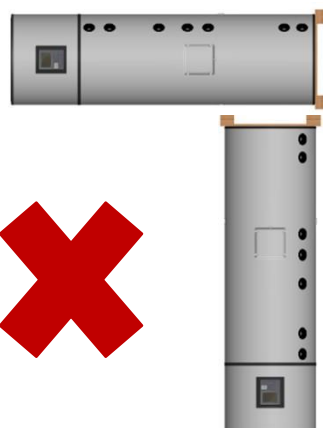

Incorrect transport position:



 WARNING	<p>During the transport and installation phase, do not take the equipment by the upper part.</p>
-------------------------------------------------------------------------------------------------------	--------------------------------------------------------------------------------------------------



The equipment must be transported in its original package to the place of installation.
 The packages contain the following information symbols:

	Fragile, handle with extreme caution		Keep the package dry
	Make sure the arrows are always up		Do not stack packages

4 INSTALLATION

4.1 Safety and Control Devices

4.1.1 High/Low Pressure Switch

In case of running outside the range of pressures recommended and defined by the supplier, the equipment will switch off and indicate error in the electronic panel.

4.1.2 Safety Thermostat

The safety thermostat is set by the supplier to ensure that the water temperature in the storage water tank with electric heater does not exceed the maximum value. If the temperature exceeds this value, the thermostat switches off the backup electrical heater. Switching on is done manually by qualified staff, after analysing the reasons for the switch off.

4.1.3 Temperature Probe

The purpose of the temperature probe is to measure the temperature values of water in the storage water tank with electric heater in order to control the system.

4.1.4 Expansion Vessel*)

The expansion vessel is a device whose purpose is to compensate for the increase in water volume due to temperature rise.

4.1.5 Safety Group*)

The safety device allows the system to be protected against anomaly situations: cold water supply, hot water flowing back, emptying of the storage water heater and high pressure. The valve is calibrated to activate at 0.7 MPa).

To drain the water in the storage water tank, you should close the supply valve and open the discharge valve.

The safety valve discharge pipe must be open into the atmosphere, because the valve may drip water or even discharge water.

The safety valve must be opened regularly to remove impurities and check that it is not blocked. The discharge pipe must be installed in a vertical position. The discharge pipe must be installed upright away from a cold environment.



Installing this device is recommended for the proper installation of the equipment.
Installing this device is the responsibility of the installer.
As a general rule it is installed in the cold water pipe.

4.1.6 Pressure Reducing Valve*)

The pressure reducing valve must always be installed upstream from the safety device, and ready to activate in situations when the pressure in the circuit exceeds 3 bar (0.3MPa). This valve comes with a pressure gauge.

*) Parts not supplied by the manufacturer. They must be installed by the installer.

4.2 Drain pan

The equipment should not be installed over an area where drains from the tank or its connections could cause damage in the adjacent area or on the lower floors of the structure. For the aforementioned reasons, it is recommended to place a drain pan under the equipment.

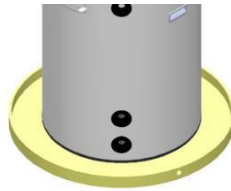

It is important that the pan has a flow channel with a minimum diameter of 3/4".

4.3 Positioning

Preliminary considerations:

- House and protect the equipment in places susceptible to ice formation;
- Choose the position closest to the main points of use;
- Always insulate the pipes;
- The ambient temperature around the equipment must not exceed 40 °C;
- The water heater should never be placed outside, also avoiding exposure to sunlight - failure to respect this parameter can lead to the exclusion of the warranty;
- Make sure that the support surface is sufficient to accommodate the weight of the water-filled water heater;
- Provide at least 500mm of space on the fronts that may require maintenance.

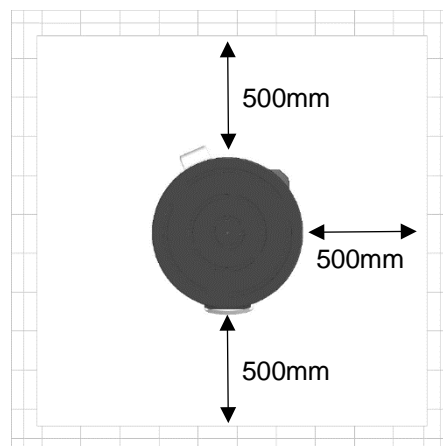

4.4 Hydraulic Installation

In the installation of the booster heat pump it is necessary to install the safety components presented below, however, an additional attention must be required on the booster heat source where a minimum water flow must be maintained of 100l/h to provide heat transfer.

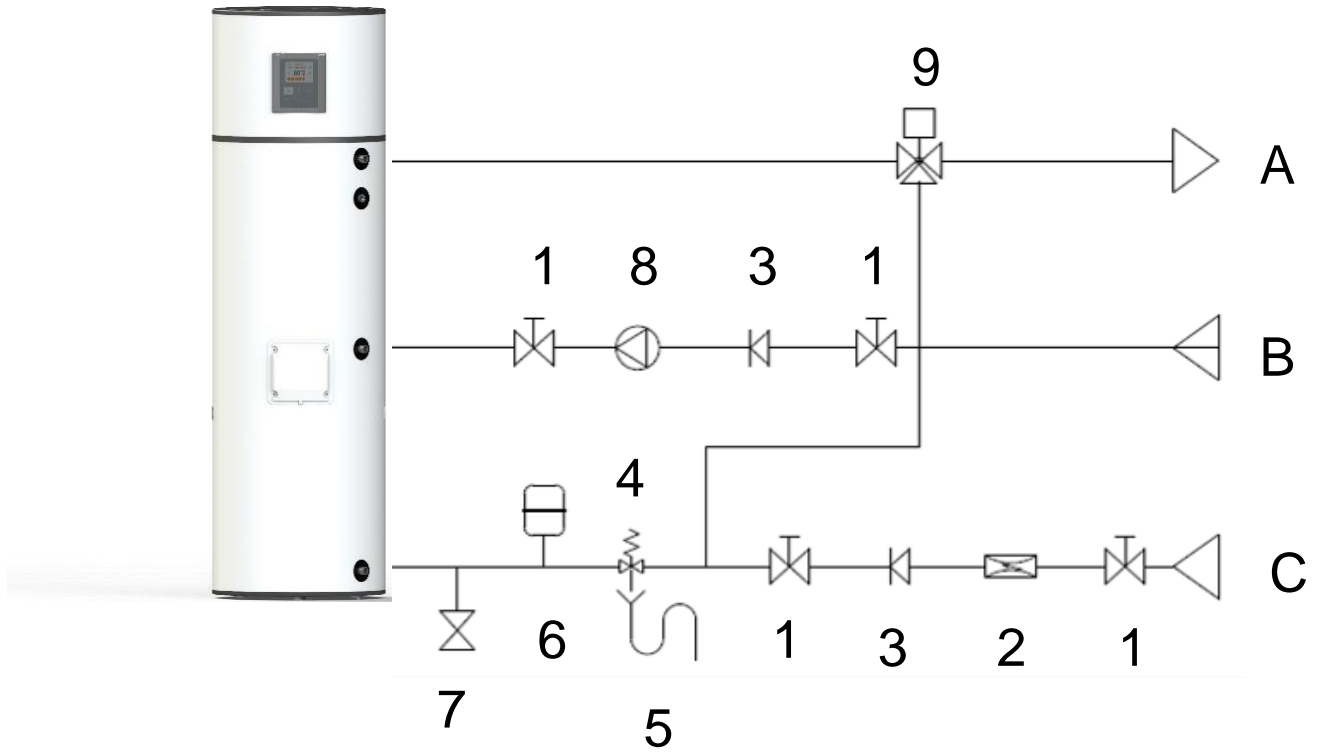

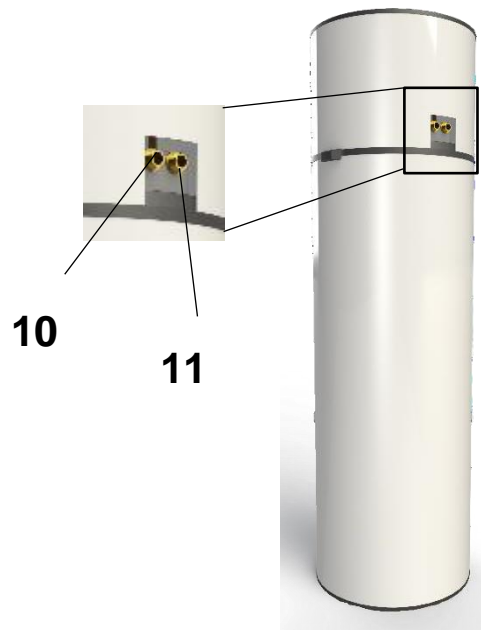

Heat source: water returning from heating radiators, district heating, etc.



Caption

- | | |
|---------------------------------------------|-----------------------------|
| 1 Shut Off Valve | 8 Circulating Pump |
| 2 Pressure Reducing Valve (3 bar / 0,3 MPa) | 9 Thermostatic Mixing Valve |
| 3 Non-return Valve | A Cold Water Inlet |
| 4 Safety group (7 bar / 0,7 MPa) | B Hot Water Outlet |
| 5 Drainage Siphon | C Recirculation |
| 6 Expansion Vessel | 10 Heat source outlet |
| 7 Drain Valve | 11 Heat source inlet |

 WARNING	<p>It is necessary to install a safety device at the cold water inlet of the appliance. The safety device must be in compliance with the standard EN 1487:2002, maximum pressure 7 bar (0.7 MPa) Water must not be stopped from flowing from the safety device to the deposit by any sort of accessory.</p> <p>The safety device must be connected with piping whose diameter is not less than the cold water inlet coupling. The discharge must be connected to a sewage siphon or, if this is not possible, elevated to a distance of at least 20 mm from the pavement to allow visual inspection; To prevent high pressure from main water supply, install a pressure reduction valve set to 3 bar (0.3 MPa).</p>
-----------------------------------------------------------------------------------------------------	--------------------------------------------------------------------------------------------------------------------------------------------------------------------------------------------------------------------------------------------------------------------------------------------------------------------------------------------------------------------------------------------------------------------------------------------------------------------------------------------------------------------------------------------------------------------------------------------------------------------------------------------------------------------------------------------------------------------------

 WARNING / DANGER		
<p>The water you use may contain impurities and/or substances damaging to the system and even harmful to your health. Make sure you use water with quality fitting for home consumption. The following table indicates some parameters that, when exceeded, must be chemically treated.</p>		
Hardness (°dH)	pH	Treatment
3,0 - 20,0	6,5 - 8,5	No
3,0 - 20,0	<6,5 - >8,5	Yes
<3,0 - >20,0	-	Yes

	<p>The Manufacture is not responsible for damage related to <u>not following these recommendations/ warnings.</u></p>
-------------------------------------------------------------------------------------	-----------------------------------------------------------------------------------------------------------------------

4.4.1 Water flow control valve

This device is equipped with a water flow control valve that regulates the amount of water that enters the evaporator according to the T3 and T2 probes. This control valve needs a minimum amount of water pressure in the circuit to regulate properly.

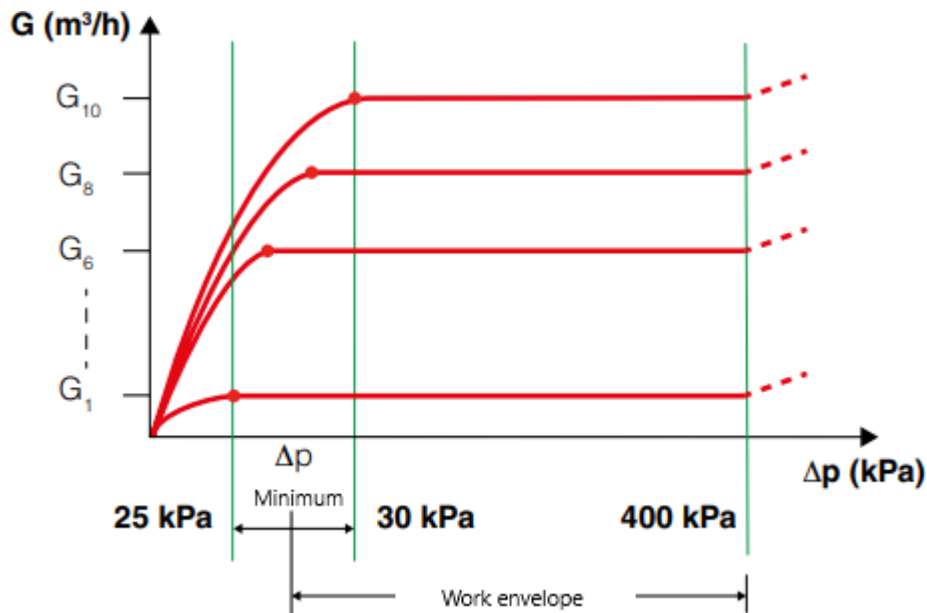

In this case, the minimum pressure required is 27 kPa in the water circuit for proper regulation of the water flow valve. When installing this equipment check if the installed water pump for water circulation can guarantee the necessary water pressure and that it does not exceed 400kPa. Regarding water flow, check if the installation allows a minimum water flow of 480 Liter/hour since the working envelop of the valve is 50 L/h to 480L/h. If the your installation exceeds a water flow of 480L/h it will be regulated by the valve to maintain correct water flow values.

4.5 Installation configuration

4.5.1 Pump configuration

When the radiant floor is serial connected to a heat source and a water pump is needed to generate the required minimum water flow value.

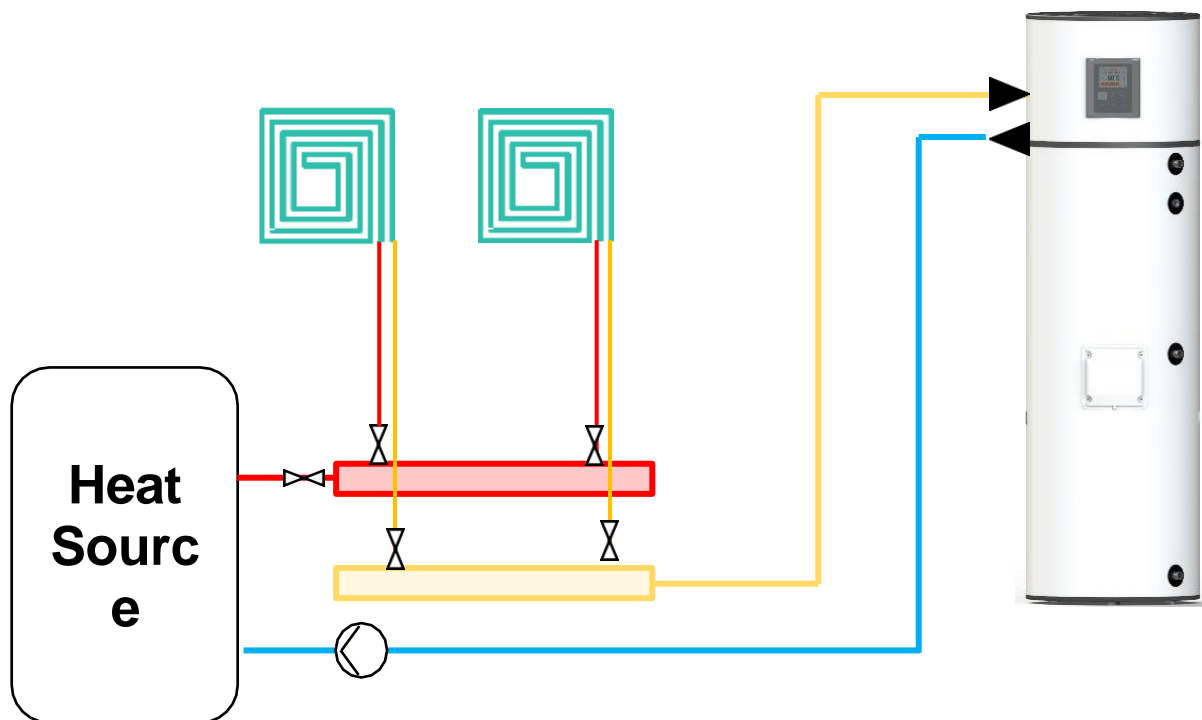

4.5.2 Valve configuration

In this configuration the radiant floor is parallel connected to the heat source where regulation valves are needed to ensure the correct water flow to the equipment and radiant floors.

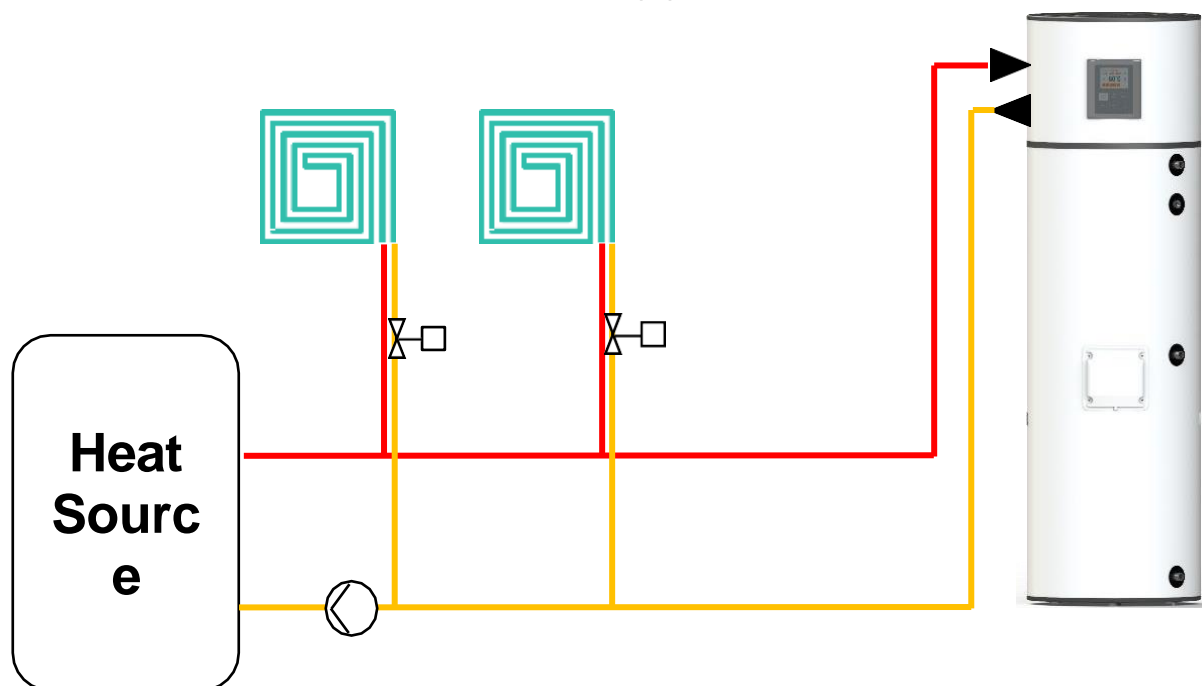

4.6 Condensates

During operation, condensation may occur. These condensates are collected in the drip tray and drained through a hole at the back of the tray. The installer must connect the condensate hose supplied by the manufacturer and direct the condensates to the drainage system or drainage siphon.



The condensate hose must not be bent/pressed and must be placed where it best suits the proper flow of condensates.

4.7 Electrical Connections

The Booster heat pump must be plugged to the power supply only after filling the storage water tank. It comes with a mains cable, to be connected to an earthed monophase voltage (230VAC/50HZ). The connections must comply with the standards of installation in effect in the territory or country where the HPWS heat pump has been installed.

The installation includes:

- Bipolar circuit-breaker with connection cable with section equal to or exceeding 2.5 mm
- Protection differential circuit breaker of 30 mA

If the power supply cable is damaged, it must be replaced by the manufacturer, by its customer service, or by staff with similar training.

5 Electrical Diagram

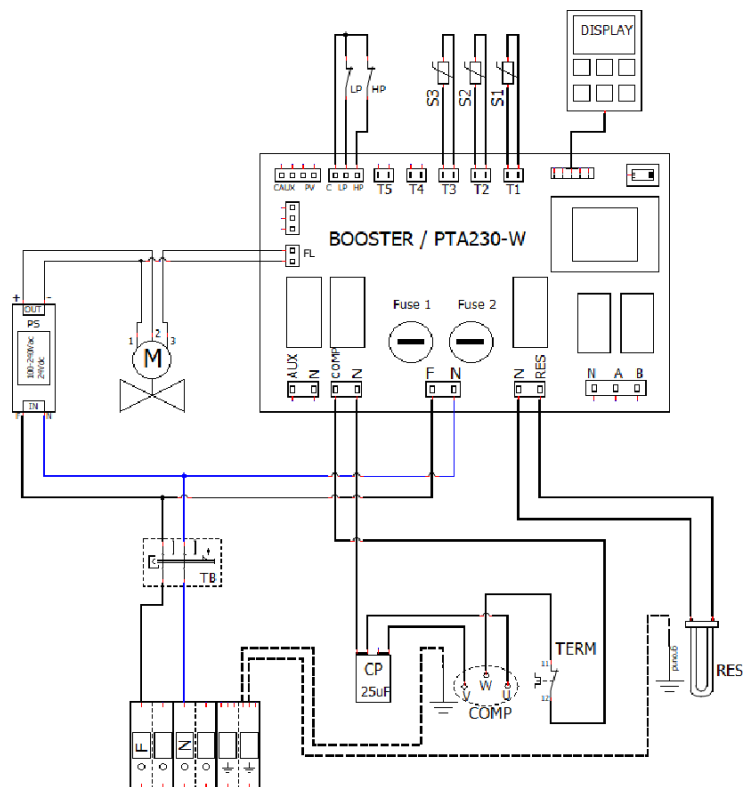

CAPTION

RES	Electrical backup heater		Ground
S1	Water temperature probe	HP	High pressure switch
S2	Heat source inlet	LP	Low pressure switch
S3	Heat source outlet	COMP	Compressor
FL	Flow control valve	TB	Safety thermostat
N	Neutral	TERM	Compressor thermal
F	Phase	T4	Solar thermal probe

6 CONTROL and PROGRAMMING

6.1 Control Panel

The control panel of the BOOSTER heat pump is simple and intuitive. It enables the configuration of several operating parameters according to the operating mode selected by the user.

It comprises six command keys (ON / OFF / CANCEL, MENU, COMP ▲, E-HEATER ▼, DISINFECT and OK / LOCK that enable checking the running of the equipment, consult and change parameters.

6.2 Keys (Functions)

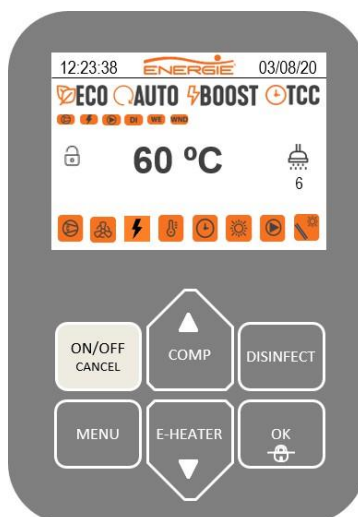







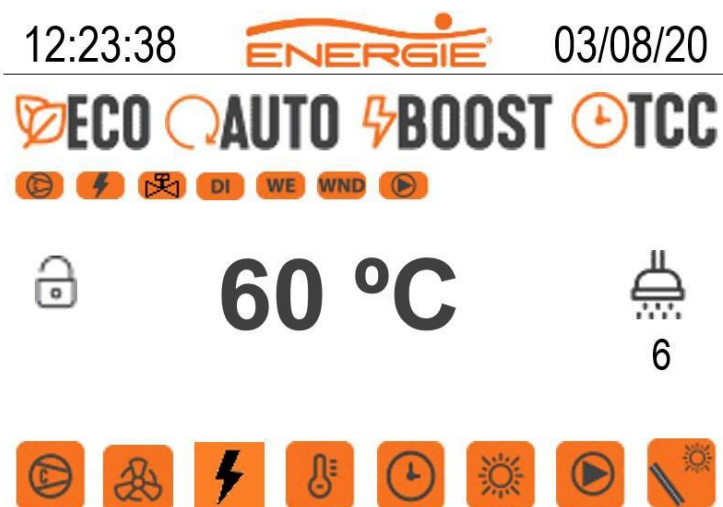







Key	Function	Description
ON/OFF CANCEL	(ON/OFF) Switch on/off	Switch on and off controller.
	(CANCEL) Exit	ESC function to exit menu, submenu or cancel a function
OK /	(OK) Confirmation	Confirm parameters within menus or submenus
	(LOCK) Lock / Unlock	Lock or unlock keyboard
MENU	MENU	Enter menu
COMP	ON/OFF Compressor	Pressing the key allows you to switch on and off the Com-pressor
E-HEATER	ON/OFF Electrical heater	Pressing the key allows you to switch on and off the electrical heater
▲ ▼	Change Values	It allows you to alter value of parameter (Inside Menu)
	Navigate through Menus/Submenus	Function to run through menus and submenus (inside Menu)
DISINFECT	(DISINFECT) Anti-legionella	Press this key and the system will automatically create a thermal shock in the water to neutralize bacteria (Legionella)

6.3 Display



















6.3.1 Interface



6.3.2 Symbols

LED	Description
 ECO	Equipment in ECO operating mode
 AUTO	Equipment in AUTO operating mode
 BOOST	Equipment in BOOST operating mode
 TCC	Timer clock control
	Compressor
	Motorized flow valve
	Electrical heater
	Disinfect
	Chrono function
	Vacation mode
	Recirculation pump function
	Solar function
°C	Water temperature
	Number of baths available
	Unlocked keyboard
	Locked keyboard

6.3.3 Symbols with Equipment Running

Symbol	Description
	Compressor ACTIVATED
	Compressor RUNNING
	Electrical heater ACTIVATED
	Electrical heater RUNNING
T 	Electrical heater ACTIVATED when $S1 < P08$ and/or $P07 > \text{Temperature } S3$ (Auto Mode)
T 	Electrical heater ACTIVATED when compressor continuous running time exceeds $T05$ (Auto mode)
MA 	Electrical heater ACTIVATED manually.
	Motorized flow valve running
	Disinfect RUNNING
	Solenoid valve RUNNING
	Chrono function ACTIVATED
DI 	Chrono function RUNNING everyday
WE 	Chrono function RUNNING only during the week (monday to friday)
WWD 	Chrono function RUNNING only during the weekend (saturday and sunday)
	Vacation mode ACTIVATED
	Recirculation pump function ACTIVATED
	Recirculation pump function RUNNING
	Solar function ACTIVATED

6.4 Start-up of the System

Before starting, check whether the installation is set up according to the recommendations and that everything is in conformity, then you may plug your equipment to the power supply.

After switching on your equipment by plugging it into the power supply, you should wait a few seconds until the controller begins to work. Then you may start your equipment following these instructions:

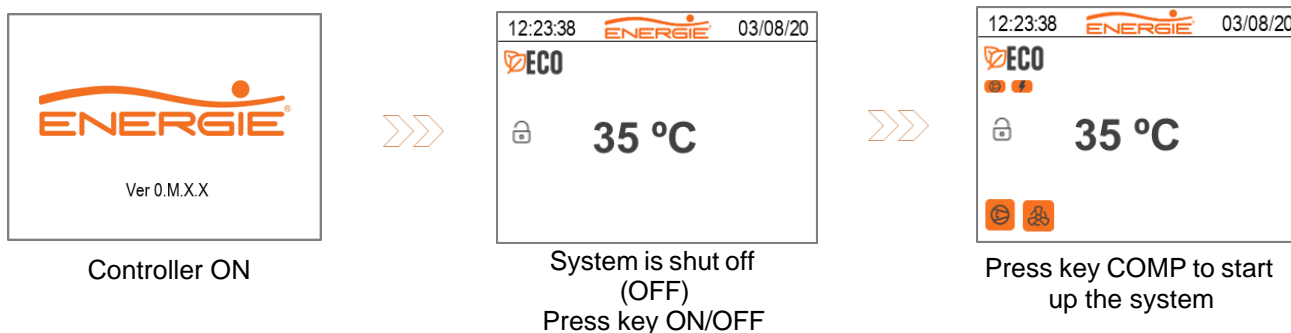

Note 1: The LED on the display indicates the status of your equipment. When is blinking means that your equipment don't have any order to work, if the LED is ON and no blinking, your system is working with the order that was given.

Note 2: To restart the appliance, switch it off and switch on again using the key ON/OFF.

6.5 Operating Modes

The HPWS heat pump is programmed to work in 3 main running modes: **ECO**, **AUTO**, **BOOST**. The equipment can also work in **TCC** (alternative energy source).

Mode	Symbol (<i>display</i>)	Description
ECO		Normal running as Heat Pump
AUTO		Optimized management of running of Heat Pump and/or Electrical Heater (backup)
BOOST		Running of Heat Pump + Electrical Heater (backup)
TCC		Running of Heat Pump + Electrical Heater (backup)

6.5.1 ECO Mode

In ECO operating mode, the equipment runs only as a Heat Pump to heat the water in the storage water tank. Thus, we could generate a greater efficiency, and savings for the user. Every time the user feels it necessary, may switch on the support electrical heater, using this mode, manually pressing the key (E-HEATER). In these circumstances the equipment will automatically change operating mode to BOOST and indicates the reason of its activation (over the electrical heater). If you switch off the electrical heater manually, the equipment will begin to run again in ECO mode.

6.5.2 AUTO Mode

In AUTO operating mode, the equipment will run as a Thermodynamic System and/or electrical heater, and the operation of the electrical heater is managed in an optimized way for the purpose of keeping up the efficiency of the equipment.

The electrical heater will start every time:

- The user activates it manually (key E-Heater).
- The contact LP opens (low external temperature, lack of fluid, leak in the circuit, etc.).
- The time for running the compressor exceeds parameter T05*
- The water temperature is below P08*.

*Parameter is adjustable (ON / OFF)

6.5.3 BOOST Mode

In BOOST operating mode, the equipment runs as a Heat Pump + Electrical Heater, and the running of the electrical heater is simultaneous with the Heat Pump. This mode enables the user to obtain hot water in less time.

The user can change the operating mode when he wishes, he need only press simultaneously the keys MENU + OK/LOCK for 3 seconds and select the mode that suits his needs with the cursor.

6.5.4 TCC Mode

The TCC function provides the possibility of raising the water temperature when an alternative power source is available (solar photovoltaic, wind or other), increasing the efficiency of the heat pump and making the alternative power source profitable.

To this end, it is sufficient to connect a cable from the inverter to the equipment's control board. The cable connection on the control board must be made at the voltage-controlled terminals. It should be noted that this is a dry contact (no voltage), applying a voltage to this contact can cause irreversible damage to the controller.

When the voltage-controlled contact closes it triggers the TCC Function and all active heat sources (Heat Pump + Electrical heater) are adjusted to new operating parameters. The compressor assumes the P01TCC/ H01TCC parameters and the electrical heater the P02TCC/ H02TCC parameters.

Note: when the voltage-controlled contact opens the equipment assumes the previously adopted operating mode.

The PV contact can also be used to take advantage of the bi-hourly tariff. For this a timer should be connected to the PV contact, instead of the inverter.

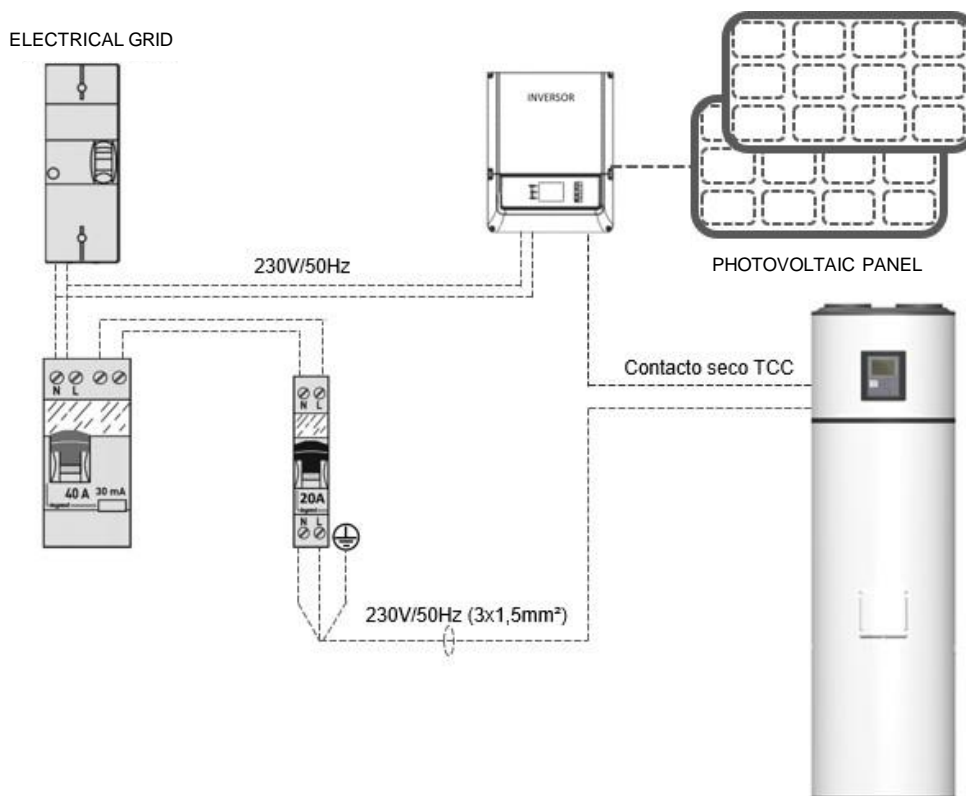
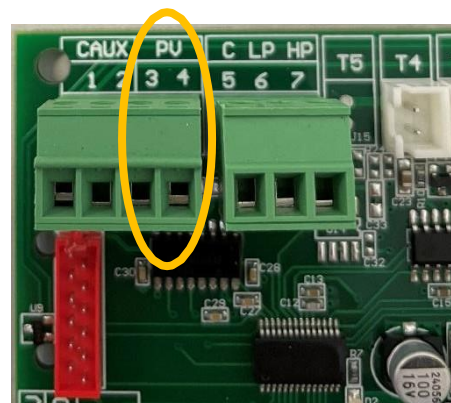

 WARNING	<p>The cable to be connected on the control card to activate the TCC mode must be a dry contact (no voltage). Applying a voltage to this contact may cause irreversible damage to the controller.</p>
-------------------------------------------------------------------------------------------------------	----------------------------------------------------------------------------------------------------------------------------------------------------------------------------------------------------------------------------

6.5.5 Chrono scheduling of the heat pump

The heat pump has an internal clock that allows the user to set two periods of operation for the control of the equipment. These periods can be distinctly defined as weekly (Monday to Friday) or weekend (Saturday and Sunday).

Once the periods of operation have been programmed, the user must then activate them, for example:

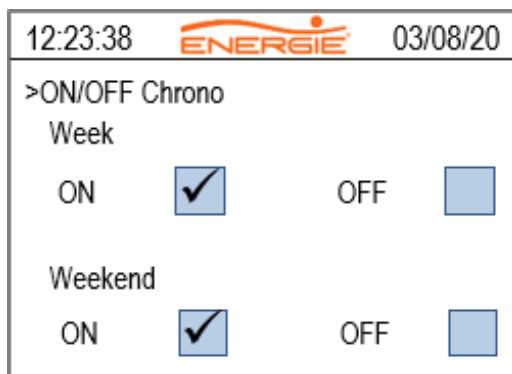

Note: The programming is set for a 24-hour period, considering first of all the lowest hour in the table, for example:

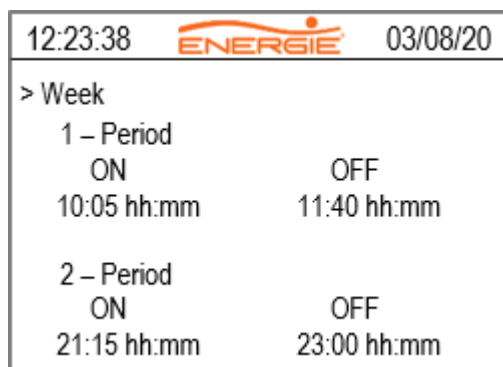

In short, the following procedures should be carried out to define the operating hours:

- 1° - Enter the menu and access the parameter "Chrono Heat Pump";
- 2° - Select, for example, a weekly schedule (Monday to Friday);
- 3° - Set the operating time for each period;
- 4° - Activate or deactivate.

6.5.6 Chrono scheduling of the recirculation pump

The heat pump has an internal clock that allows the user to set two periods of operation for the pump of recirculation. These periods can be distinctly defined as weekly (Monday to Friday) or weekend (Saturday and Sunday).

Once the periods of operation have been programmed, the user must then activate them, for example:

12:23:38		03/08/20
>ON/OFF Chrono recirculation pump		
Week		
ON	<input checked="" type="checkbox"/>	OFF <input type="checkbox"/>
Weekend		
ON	<input checked="" type="checkbox"/>	OFF <input type="checkbox"/>

Note: The programming is set for a 24h-period, considering first of all the lowest hour of the table, for example:

12:23:38		03/08/20
> Week		
1 – Period		
ON		OFF
10:05 hh:mm		11:40 hh:mm
2 – Period		
ON		OFF
21:15 hh:mm		23:00 hh:mm

In short, to set the operating time of the pump of recirculation the following procedures must be carried out:

- 1° - Enter the menu and access the parameter "Chrono Recirculation Pump";
- 2° - Select, for example, a weekly schedule (Monday to Friday);
- 3° - Set the operating time for each period;
- 4° - Activate or deactivate.

6.5.7 Additional functions

The heat pump controller has four additional functions available. These functions allow the management/control of a solar thermal installation and pump of recirculation.

To configure these functions, it is necessary to enter the installer level of access (F11), access the submenu parameters (F08) and select parameter P12.

According to the value of the parameter set in parameter P12, the controller assumes the following functions:

Parameter P12 = 0:

Management/control of solar thermal installation and pump of recirculation is inactive.

Parameter P12 = 1:

The heat pump controller assumes the control of the solar thermal installation in parallel with the operation of the heat pump.

Depending on the temperature probe value S4 (solar collector) and the temperature probe value S1 (inside the water tank) the solar pump of recirculation "Ps" is activated.

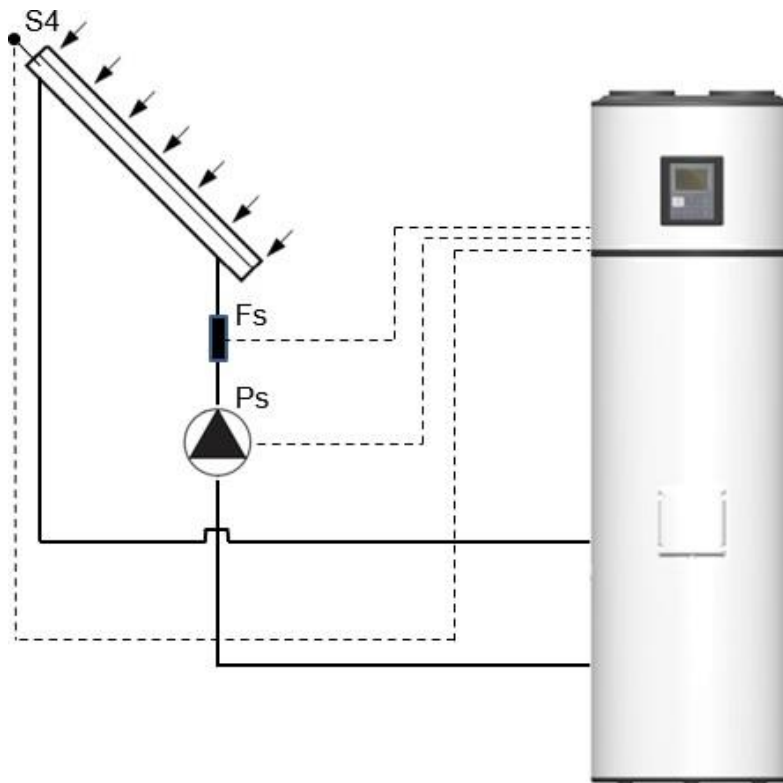

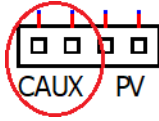
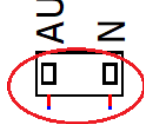
Code	Description	Connection terminals
S4	Solar collector temperature probe (NTC10KΩ@25°C)	 Terminal T4
Fs	Flow switch	 Terminal CAUX
Ps	Solar pump of recirculation	 Terminal AUX/N

Parameter P12 = 2:

In the presence of a "SC" electronic control unit to control the solar thermal installation, it is possible to put the heat pump on standby whenever there is solar production, this is, when the solar thermal installation is producing the electronic control unit activates the auxiliary contact "CAUX" and the heat pump automatically goes on standby. As soon as the auxiliary CAUX contact is inactive the heat pump automatically switches to normal operation.

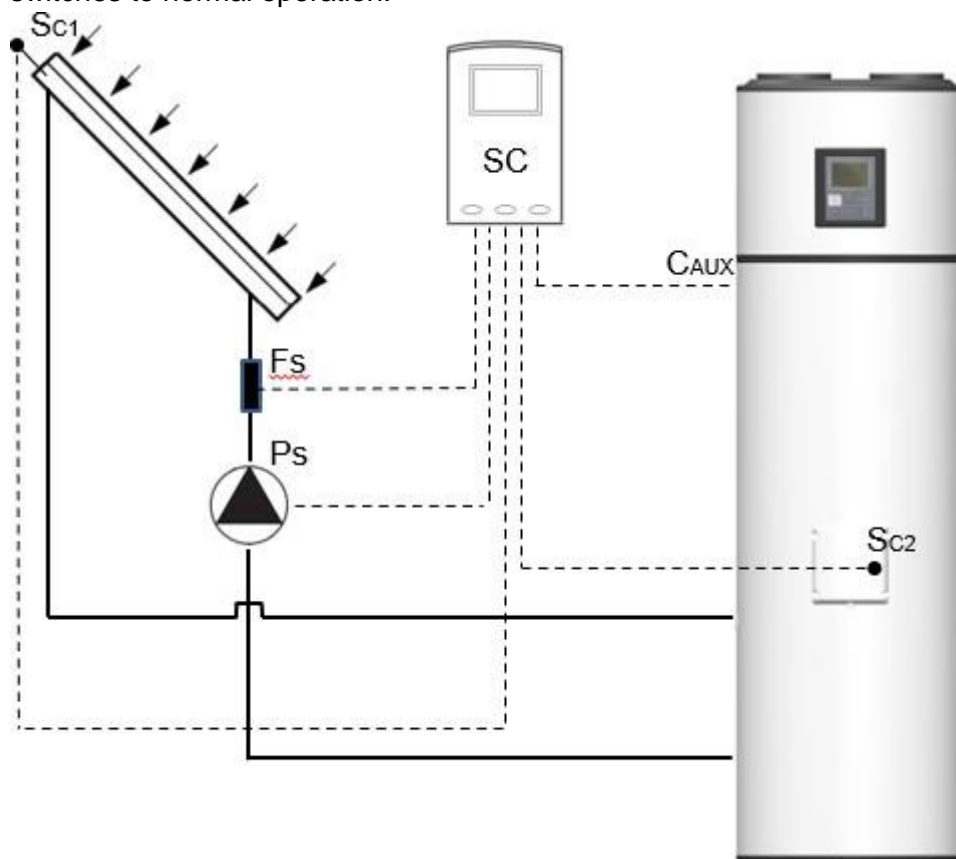

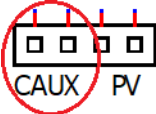

Code	Description	Connection terminals
SC	Solar electronic control unit	Connections in the solar electronic control unit
Sc1	Solar collector temperature probe	
Sc2	Storage water heater temperature probe	
Fs	Flow switch	
Ps	Solar pump of recirculation	
CAUX	Auxiliary contact for heat pump control (contact free of "dry contact" voltage). Closed CAUX contact - heat pump in standby; Open CAUX contact - Heat pump in normal operation.	 Terminal CAUX

Parameter P12 = 3:

In the presence of a "SC" electronic control unit to control the solar thermal installation, it is possible to put the heat pump on standby whenever there is solar production, this is, when the solar thermal installation is producing the electronic control unit activates the auxiliary contact "CAUX" and the heat pump automatically goes on standby. As soon as the auxiliary contact "CAUX" is inactive the heat pump automatically switches to normal operation.

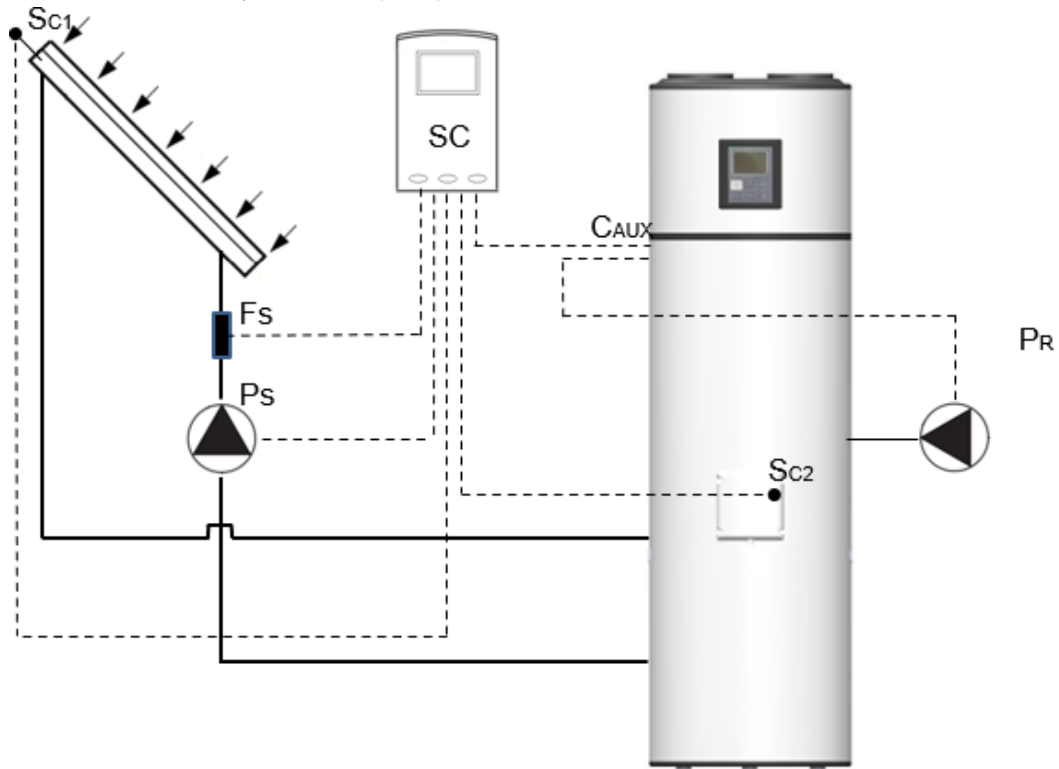
Regardless of whether the heat pump is on standby or in normal operation, control of the "PR" pump of recirculation is ensured by the heat pump controller.

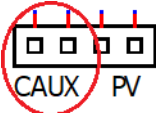

Code	Description	Connection terminals
SC	Solar electronic control unit	Connections in the solar electronic control unit
Sc1	Solar collector temperature probe	
Sc2	Storage water heater temperature probe	
Fs	Flow switch	
Ps	Solar pump of recirculation	
CAUX	Auxiliary contact for heat pump control (contact free of "dry contact" voltage). Closed CAUX contact - heat pump in standby; Open CAUX contact - Heat pump in normal operation.	 Terminal CAUX
PR	Pump of recirculation	 Terminal AUX/N

Parameter P12 = 4:

The heat pump controller assumes the control of a recirculation pump in parallel with the heat pump control.

The pump of recirculation is driven by the hourly period set by the user and the temperature in the heat accumulator.

NOTE: The pump of recirculation only comes into operation when there is a defined time period, active period, and the compressor or electrical heater is active.

PR – Recirculation Pump

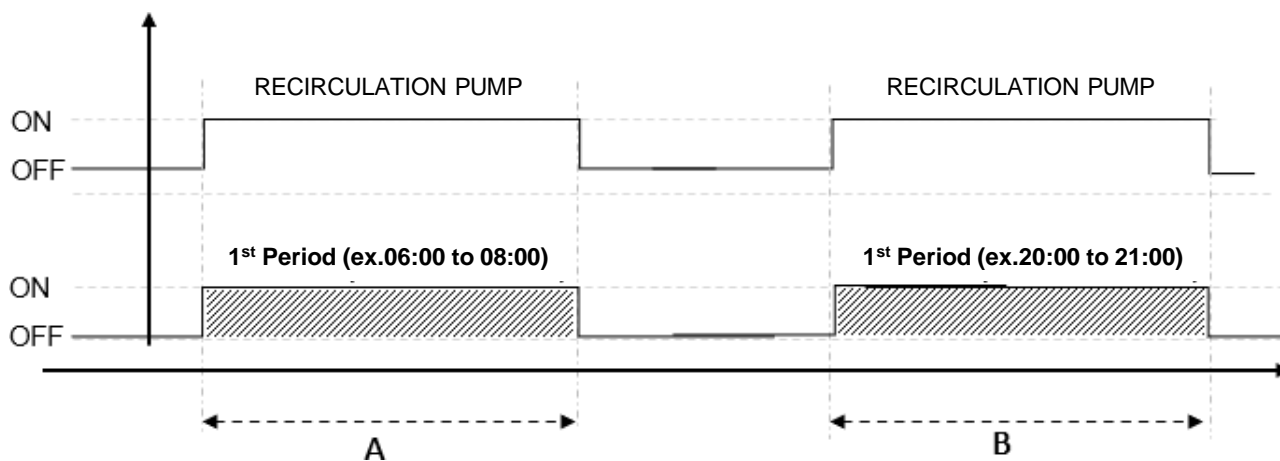
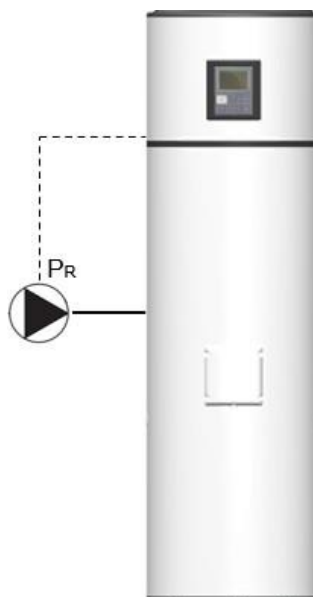

Condition	Description	Pump connection terminal
A e B	Pump of recirculation active whenever: <ul style="list-style-type: none"> • Temperature at probe S1 > P13; • Defined and active time period; • Active compressor or electrical heater. If none of these conditions are met, the pump of recirculation will not work.	Terminal AUX/N

6.6 Extra Modes

6.6.1 DISINFECT

The HPWS electronic control features the Disinfect function, which consists of a water heating cycle up to 65 °C, for a period of time long enough to prevent the formation of germs inside the tank. The Disinfect function can be set automatically or manually. In automatic mode, the user has the possibility of setting the function every week or every month. When automatic mode is not activated, the user must activate it manually on the key Disinfect.

At the end of the function, the system returns to the operating mode that was selected at the beginning.

6.6.2 VACATION Mode

To activate the vacation function you need to access the menu and set the number of days on holiday that you wish, and your equipment will automatically enter Standby mode until the last day of holidays. On the last day, the equipment will begin the Disinfect function to eliminate any formation of germs that appeared in the storage water tank during the time you were absent.

After the holidays and once the program Disinfect is over, the equipment will resume the mode selected (ECO, AUTO or BOOST).

Note: If you set your equipment to enter Vacation mode and turn it off with the key ON/OFF, the function becomes inactive. When you return from your holidays you must remember to switch on your equipment and cancel the days of holidays introduced (Value=0). If you do not carry out this operation, your equipment will not restart until the days of holidays selected have expired.

6.7 Menu

Every time it becomes necessary to alter or set new parameters in the running of the equipment, the user must access the Menu.

To access the menu, the key MENU must be pressed for 3 seconds.

After access use the keys COMP ▲ and E-HEATER ▼, to navigate the menus and submenus. In order to confirm values / parameters press the key OK/LOCK. Press the key CANCEL to exit the menu.

6.8 Changing Mode

The equipment is set by default to work in the “ECO” operating mode. If the user wishes to alter the operating mode, he/she must follow these procedures:

Unblock the keyboard and press the key Menu.

Using keys ▲ ▼ run through menu and select F05, access submenu and select the operating mode.

Note: In order to change the operating mode, is not necessary to reinitiate the equipment.

6.9 Number of Showers Available

The user can consult the number of showers available on the home page of the graphical interface (display) by using a volume of hot water at a temperature of 40°C or more.

On the initial page of the display, the parameter mentioned in this chapter will be displayed by resorting to the icon of a shower, with the number indicating the number of showers being positioned below.

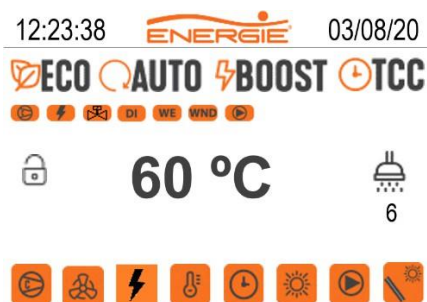

Relevant considerations:

- The illustrative set presented above will not be visible on the display whenever the water temperature inside the tank is below 38°C;
- The number of available showers is calculated considering that one shower is approximately equivalent to a consumption of 50L of domestic hot water;

6.10 Consultation of probe temperatures (S1, S2, S3)

As shown below, on the initial page of the display it is possible to consult the temperatures of the probes:

- **S1** – Water temperature probe
- **S2** – Heat source water inlet
- **S3** – Heat source water outlet



In order for the user to be able to view these parameters, it is sufficient to select the keys on the display initial page ▲ ▼.

6.11 Source control flow

The heat source flow is controlled by a flow valve that reduces or increases the flow according to the difference between the heat source inlet and outlet to maintain it in the ideal conditions.

7 CHECKING GOOD RUNNING CONDITION

Before starting your heat pump, check if the tank filled with water and the heat source circuit is connected.

To check that your equipment is working properly put it into operation and wait at least 20 to 30 minutes and then check the following conditions:

- Check the heat source water flow after 10min to check if it is above 100l/h which is the minimum value required. Increase the water flow if it does not achieve the minimum value.

8 PARAMETERS DESCRIPTION

Code	Type	Function	Min	Max	Default	Units
F01	Language	Portuguese English Français Deutsch Italiano Espanol Nederlands	---	---	English	---
F02	Clock	Date and Time	---	---	---	---
F03	Chrono Heat Pump	Week Weekend ON/ OFF chrono	---	---	Chrono = OFF	---
F04	Chrono Recirculation Pump	Week Weekend ON/ OFF chrono	---	---	Chrono = OFF	---
F05	Mode	Eco Boost Auto	---	---	Eco	---
F06	Holidays	Number of days	1	99	0	---
F07	Disinfect	Disinfect function inactive Disinfect function active once a week (weekly) Disinfect function active once a month (monthly) Number of days	---	---	Inactive	---
F08	Parameters	P01 - Setpoint Compressor 1	10	60	52	°C
		H01 - Gradient P01	2	20	2	°C
		P02 - Setpoint Electrical heater	10	65	52	°C
		H02 - Gradient P02	1	20	3	°C
		P01 TCC Setpoint Compressor	10	60	55	°C
		H01 TCC Gradient P01 TCC	2	20	2	°C
		P02 TCC Setpoint Electrical heater	10	65	65	°C
		H02 TCC Gradient de P02 TCC	2	20	15	°C
		P05 - Safety temperature	70	80	75	°C
		P06 - Setpoint disinfect	60	70	65	°C
		P08 - Temp. min water to activate electrical heater (AUTO mode)	10	40	30 ON	°C
		H10 – Gradient P10	2	20	7	°C
		P11 – Gradient to activate the Solar Thermal Pump	2	10	5	°C
		P12 – Additional Functions	0	4	0 – Inactive	***
		P13 – Minimum water temperature to activate the recirculation pump	20	50	30	°C
		P14 – Minimum power for PV function	0	3200	500	W
		P15 – Differential AC	20	40	30	°C
		P16 – Min. output signal W. valve	10	40	10	%
		P17 – Max output signal W. valve	60	100	95	%
		P18 – Min temp. water	5	20	5	°C
P19 – Max. temp. water	40	60	50	°C		
T01 (timer) – Delay time to compressor starts running	1	20	2	min		
T02 – Not used	-	-	-	-		
T04 – Not used	-	-	-	-		
T05 (timer) – Maximum time compressor running	6	15	12	hours		

		T07 (timer) – Delay time to compressor starts running after LP error	1	20	10	min
		T11 (timer) – Delay time LP alarm	1	10	1	min
		T12 (timer) – Delay time water flow alarm	5	120	10	sec
		T13 (timer) – Delay time to restart the solar thermal pump	1	10	5	min
		T14 (timer) – Water valve output signal refresh time	5	100	1	seg
		T15 (timer) – Enable water valve output signal	1	1	1	-
F09	INFO	Temperature Probe 1 Temperature Probe 2 Temperature Probe 3 Temperature Probe 4 P01 Setpoint compressor H01 Gradient P01 P02 Setpoint Electrical heater H02 Gradient P02 P05 Water temperature alarm P06 Setpoint anti-legionella H10 Gradient P10 P12 Additional Functions T01 Delay compressor starts running T05 Maximum time compressor running Next Disinfect Compressor instant consumption Electrical heater instant consumption			---	---
F10	Efficiency	Energy consumption <ul style="list-style-type: none"> Compressor (instant W) Electrical heater (instant W) Compressor (daily kWh) Electrical heater (daily kWh) Compressor (total kWh) Electrical heater (total kWh) Energy savings <ul style="list-style-type: none"> Energy savings (kWh) 	---	---	---	---
F11	Levels of access	Installer	Password: 0022			---
		Manufacturer	Password: ****			---
F12	Test Outputs	COMP - Contact N.O Compressor output	---			---
		RES - Contact N.O Electrical heater output	---			---
		FL - Motorized flow valve	---			---
		AUX - Contact N.O Auxiliary contact output (recirculation pump / Solar thermal pump)	---			---
F13	Errors	Elist – Errors list	---			---
		Ereset – Delete errors list	---			---
F14	Restore Values	Restore all the parameters to factory values	---			---

9 ERRORS

The installation, assembly and repair of the equipment can only be carried out by qualified technicians.

Symbol	Description	Problem / Checking
Er01 – S1	Probe 1 OFF.	Lack of temperature probe. Check for probe. Probe disconnected from controller – Check that the connector is well attached to the electronic plate and/or the connection terminals are secure.
Er02 – S2	Probe 2 OFF.	
Er03 – S3	Probe 3 OFF.	
Er04 – S4	Probe 4 OFF.	
Er11 – S1	Probe 1 short circuit	Damaged probe – Measure internal resistance of probe which is approximately 10 KΩ at the temperature of 25 °C.
Er12 – S2	Probe 2 short circuit	
Er13 – S3	Probe 3 short circuit	
Er14 – S4	Probe 4 short circuit	
Er20 – TA	Anomaly detected in the water temperature	Water temperature in storage water heater is too hot – Check that there is no anomaly in the electronic board, such as a damaged relay. Temperature probes in short-circuit – Measure internal resistance of probe, it should be approximately 10 KΩ at the temperature of 25 °C, check that the connector is well attached to the electronic plate and the connection terminals are in good condition.
Er22 – LT	Water low temperature alarm	Water temperature in the boiler lower than 0 °C.
Er23 – LP	Protection system active	Low Pressure switch – Verify if the switch is well connected in the command panel. Low external temperatures Lack of refrigerant – Incomplete refrigerant charge or leak..
Er24 – HP	Protection system active	High pressure switch – Verify if the switch is well connected in the command panel. Fluid circuit obstructed (expansion valve or filter).
Er25 – FS	Protection system active	Lack of water / water circuit obstructed in the solar thermal installation;
TEVAP_LT	Low temperature in plate exchanger	Check temperature of the heat source water; Check the water flow; Check if the water flow regulation valve is working properly.
TIN_HT	High heat source inlet temperature	Check temperature of the heat source water
FL	Outlet temperature higher than inlet temperature	Check the hydraulic connections to see if they are connected to the correct positions.
H_CAP	Insufficient heat capacity	Check refrigeration circuit (lack of refrigerant). Check flow regulation valve.
LINK ERROR	Communication failure between display and power board	Connection cable between display and command panel – Check the cable is in good condition or that the plugs are correctly inserted (display and command panel)
Pcp	Anomaly detected in the compressor	Compressor is active but not working – check that the compressor fuse is blown and/or if the compressor connection terminals are well connected.
Phe	Anomaly detected in the electrical heater	Electrical heater is active but not working – check the status of the electrical heater and/or if the connection terminals are well connected.

10 PROBE CHART

The probes installed in the equipment (S1, S2, S3 e S4) are NTC 10k Ω @25°C.

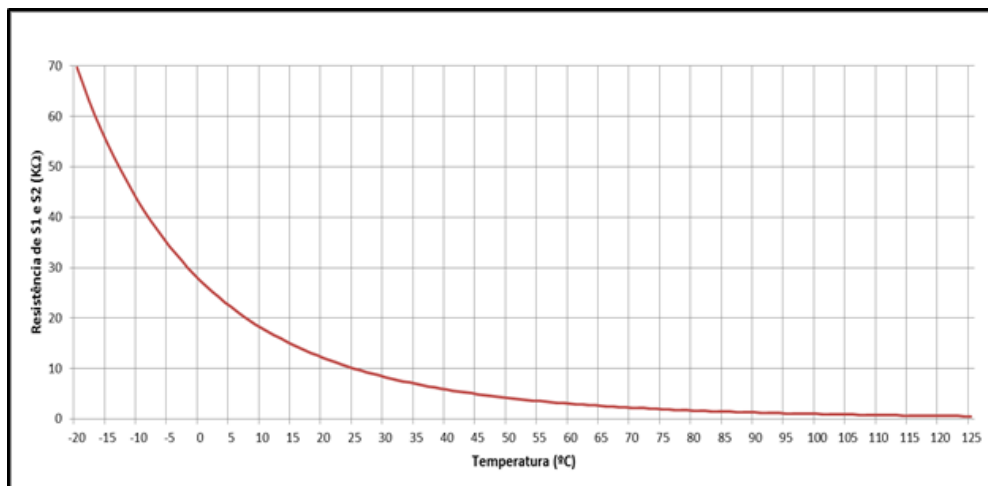



11 TROUBLESHOOTING

Problem	Possible Causes	How to Proceed
Failure in electronic board	Power supply failure	Check the power supply Check the corresponding circuit breaker
	Cable damaged or disconnected	Check the integrity of the electronic board's electric circuit
Low water temperature or lack of hot water	Low temperature programmed as the set-point	Adjust the temperature of the set-point. 53°C from factory
	Error activation	Check the presence of error on electronic board and consult the table of errors
	Cable damaged or disconnected	Check the connection of equipment to the plug Check that the corresponding circuit-breaker is connected Check the integrity of the cables Check that the electrical cable is disconnected from the power board Check electric protection (fuse)
	Vacation mode ON	Turn OFF the vacation mode
	Equipment or compressor OFF	Check "5.4 Start up of the system"
	Use of large amount of hot water	Change the equipment to "BOOST" mode for a fast water heating
	Return of hot water into the cold water circuit (safety device incorrectly installed or damaged)	Shut off the cold water supply valve to switch off the safety device. Open a hot water tap. Wait 10 minutes and if you get hot water, replace the faulty plumbing and/or proceed with the correct positioning of the safety device Clean the filter of the safety device
	ECO Mode selected and low external temperature	Change the equipment to "AUTO" mode to initiate automatic management of system Change the equipment to "BOOST" mode for a fast water heating
Electric heater OFF	Make sure the backup electric heater has power supply	
Water is too hot and/ or there is steam	Problem with the probe	Check error display on electronic board
	Problem with the safety thermostat	Check correct running of safety thermostat
	Low water temperature	The running of the equipment depends on the inlet water temperature
	Low voltage installation	Make sure the installation is supplied with the indicated value for voltage
	Heat pump Error	Check the error display in the electronic board

Problem	Possible Causes	How to Proceed
Low hot water flow rate	Hydraulic circuit blocked	Check the condition of the hydraulic circuit
Water discharge on the safety group	Absence or incorrect sizing of expansion vessel (if leak is not continuous)	Installation and/or correct dimensioning of expansion vessel
	High mains pressure (if leak is continuous)	Check the reducing pressure valve (if installed) Install a reducing pressure valve (if not installed)
Power consumption is abnormally high and constant	Leak or obstruction in refrigerant circuit	Check that the piping is not damaged Use equipment suitable for checking leaks in the circuit
	Dire environmental conditions	
Electrical heater not working	Safety thermostat ON	Check the condition of the thermostat
	Defective electric heater	Check the electric heater
Bad odour	Absence of siphon or siphon without water	Install and make sure the siphon has water
Undraining condensation	Drainage circuit blocked	Clean the condensation circuit
	Drain pipe blocked	Check the draing pipe

12 SYSTEM MAINTENANCE

	<p>Before undertaking any maintenance operation on the equipment, make sure it is not plugged to the power supply!</p>
-----------------------------------------------------------------------------------	------------------------------------------------------------------------------------------------------------------------

	<p>Although the fluid in the cooling circuit is environmentally-friendly, it must not be released into the atmosphere. Forms of recovery must be arranged.</p>
-----------------------------------------------------------------------------------	--------------------------------------------------------------------------------------------------------------------------------------------------------------------

12.1 General Inspection

During the equipment's useful life, the owner should carry out a general inspection of the equipment, according to the place where the equipment is set up:

- External cleaning of equipment and surrounding areas with a wet cloth;
- Visual inspection of the whole equipment, with the purpose of detecting possible leaks and damaged devices.

12.2 Empty the Water Storage

	<p>Remember that the water in the storage water tank is at a high temperature, so there is an associated risk of burns. Before emptying the storage water tank, allow the water temperature to drop to a level that avoids burns.</p>
------------------------------------------------------------------------------------	-------------------------------------------------------------------------------------------------------------------------------------------------------------------------------------------------------------------------------------------

After ensuring the water temperature is at a safe level that will avoid burns, follow this procedure:

- Unplug the system from the power supply
- Shut off the water supply valve and open a hot water tap
- Open the system discharge valve

12.3 Filter of Reduction Valve

To periodically clean the filter of the reduction valve, you should:

- Shut off the water supply.
- Turn anti-clockwise until you remove tension from the spring
- Remove the handle
- Remove filter and clean

12.4 Condensate circuit

Make sure you check the condensate draining system and the drip tray in the maintenance and cleaning service routines of your system. Clean the drip tray used as it may contain accumulated dust from the outside, which may obstruct the condensates drainage holes. Make sure the holes and the condensate outlet pipe are not obstructed.

12.5 Safety Thermostat

The safety thermostat is deactivated whenever there is an anomaly in the system, so every time you plan

to activate it, find out what happened that caused it to change its status mode.

If you were not able to determine what happened and it is still deactivated, contact customer service to have your problem solved.

EN

Warranty

This warranty covers all defects to the confirmed materials, excluding the payment of any type of personal damage indemnity caused directly or indirectly by the materials.

The periods indicated below start from the purchase date of the apparatus, 6 months at the latest from the leaving date from our storage warehouses.

Water Cylinder

(Domestic and Industrial)

5 Years: Stainless Steel (2+3 Years)*

5 Years Enamelled (2+3 Years)*

Manufacturer Warranty

Thermodynamic

Solar Panel

10 years against corrosion

Electrical components and moving parts:

- Thermodynamic Block
- Solar Block
- Solarbox
- Split
- Monobloc (except cylinder)
- Thermobox
- Inverter

2 Years

*The warranty extension of 3 years, against corrosion of the internal tank (Enamelled / Stainless Steel), is conditioned to the submission of:

- Warranty and Check Sheet at maximum 15 days after the installation.
- Documental evidence of the magnesium anode annual replacement (if applicable).
- Pictures of the installation where it's shown safety group, expansion vessel, hydraulic and electrical connections.

In case of warranty, the parts replaced are property of the manufacturer. A repair under the warranty is not reason for an extension of its term.

Warranty Exclusions

The warranty ceases to be effective when the apparatus is no longer connected, used or assembled in accordance with manufacturer instructions, or if there has been any form of intervention by unauthorized technicians, has the appearance of modifications and/or if the series number appears to have been removed or erased. The equipment should be installed by qualified technicians according to the rules in effects and/or the rules of the trade, or the instructions of our technical services. Further exclusions from warranty:

- Hot water tanks have been operating in water with the following indexes:
 - o Active chlorine > 0.2 ppm
 - o Chlorides > 50 mg/l (Inox)
 - o Hardness > 200 mg/l
 - o Conductibility > 600µS/cm (20°C)
 - o PH < 5,5 or PH > 9 (Sorensen at 20°C)
 - o Magnesium > 10 mg/l
 - o Calcium > 20 mg/l
 - o Sodium > 150 mg/l
 - o Iron > 1 mg/l
 - o If one of the water parameters has a higher value than stipulated by directive 236/98 (Portugal) or equivalent standard in the costumer's country
- Parts are subject to natural wear and tear – levers, switches, resistances, programmers, thermostats, etc.
- Breakdown due to incorrect handling, electrical discharges, flooding, humidity or by improper use of the apparatus.
- The warranty lapses if it is transferred to another owner, even if within the guarantee period.

NOTE: This sheet must be properly filled, signed and stamped by the installer / reseller and returned to ENERGIE EST, Lda., otherwise the warranty will not be validated.

Send this installation sheet to warranty@energie.pt, writing the serial number of the equipment as subject.



ErP
READY

APPLIES TO
EUROPEAN
DIRECTIVE
FOR ENERGY
RELATED
PRODUCTS



Informação mais detalhada em
energie.pt



Siga-nos em
ENERGIE PORTUGAL

Morada Zona Industrial de Laúndos, Lote 48
4570-311 Laúndos – Póvoa de Varzim PORTUGAL
Coordenadas GPS N 41 27.215' , W 8 43.669'
Telefone + 351 252 600 230

Fax + 351 252 600 239
E-mail energie@energie.pt
Web www.energie.pt

Projeto co-financiado por:



UNIÃO EUROPEIA
Fundos Europeus
Estruturais e de Investimento

O presente folheto foi criado apenas para informar e não constitui uma oferta contratual para a ENERGIE Est Lda. A ENERGIE Est Lda. compilou o conteúdo deste folheto de acordo com o melhor dos seus conhecimentos. Não é dada qualquer garantia expressa ou implícita no que toca à totalidade, precisão, fiabilidade ou adequação para um determinado fim do seu conteúdo e dos produtos e serviços que apresenta. As especificações estão sujeitas a alterações sem aviso prévio. A ENERGIE Est Lda. rejeita explicitamente quaisquer danos diretos ou indiretos, no seu sentido mais amplo, resultantes ou relacionados com a utilização e/ou interpretação deste folheto.

