



ECO

200i | 250esm | 250i | 250ix | 300esm | 300i | 300ix
200is | 250is | 250isx | 300esms | 300is | 300isx | 500is | 500isx



Esteemed Client,

We would like to thank you for your choice when you acquired an equipment for sanitary water heating.

The thermodynamic solar system **ECO** system will surely meet all your expectations and provide many years of comfort with maximum power saving.

Our organization dedicates much time, energy and economic resources in order to develop innovations that will promote power saving in our products.

Your choice has demonstrated your good sense and concern with power consumption, a matter that affects the environment.

We have taken on a permanent commitment to conceive innovative and efficient products so that this rational use of energy can actively contribute to the preservation of the environment and natural resources of the planet.

Keep this manual whose objective is to inform, alert and advise about the use and maintenance of this equipment.

Our services are always at your disposal. Feel free to call upon us!



Index

1. INTRO.....	6
1.1 Symbols.....	6
1.2 Safety Information	6
1.3 Information	7
2 PACKAGE.....	9
2.1 Contents	9
2.2. Transport.....	10
3 SPECIFICATIONS.....	11
3.1 Running Principle	11
3.2 Technical Features (1 panel).....	12
3.3 Technical Features (2 panels)	13
3.4 Main Components	14
3.4.1 General Diagram of Assembly	14
3.4.2 Dimensions	15
3.4.3 ID Plate	16
3.4.4 Thermodynamic Solar Panel.....	17
3.4.5 Thermodynamic Block + Storage Water Heater.....	18
3.4.6 Refrigerant	19
3.5 Safety and Control Devices	19
3.5.1 Low Pressure Switch	19
3.5.2 Safety Thermostat.....	19
3.5.3 Temperature Probe.....	19
3.5.4 Protection Against Corrosion (if applicable)	19
3.5.5 Dielectric Joint (enamelled boilers)	19
3.5.6 Expansion Vessel*	20
3.5.7 Safety Group.....	20
3.5.8 Pressure Reducing Valve	20
4 INSTALLATION	21
4.1 Attachment of the Panel	21
4.2 Positioning.....	23
4.3 Installation of Thermodynamic Block.....	23
4.4 Refrigerant Connections.....	24
4.4.1 Connections to the panel	24
4.4.2 Connection of thermodynamic block to the storage water heater	27
4.4.3 Connection of thermodynamic block and panel	27
4.4.4 Load of Nitrogen	29
4.4.5 Vacuum.....	29
4.4.6 Checking good running condition.....	30
4.4.7 Load of complementary refrigerant (if necessary)	30
4.5 Hydraulic Connections.....	30
4.6 Electrical Connections	31
4.6.1 Wiring diagram (1 Thermodynamic Panel).....	32
4.6.1 Wiring diagram (2 Thermodynamic Panels).....	33
5 FIRST USE.....	34
5.1 Filling the Tank	34
5.2 Start Up of the System	34

6	SYSTEM OPERATION.....	35
6.1	Control Panel.....	35
6.2	Keys (Functions).....	35
6.3	Interface Symbols.....	36
6.4	Operating Modes.....	36
6.4.1	ECO Operating Mode	37
6.4.2	AUTO Operating Mode	37
6.4.3	BOOST Operating Mode.....	37
6.5	Extra Modes	37
6.5.1	DISINFECT Function	37
6.5.2	VACATION Mode.....	38
6.5.3	PV Mode	38
7	SYSTEM MENU	39
8	ERRORS	39
9	PARAMETERS DESCRIPTION	40
10	PROBE CHART.....	41
11	TROUBLESHOOTING.....	41
12	SYSTEM MAINTENANCE.....	42
12.1	General Inspection	42
12.2	Magnesium Anode (if applicable)	43
12.3	Filter of Reduction Valve	43
12.4	Safety Thermostat.....	43
12.5	Empty the Water Storage	44
13	DISPOSAL OF EQUIPMENT.....	44

1. INTRO

1.1 Symbols

	<p>Every process that the supplier believes to be conducive to harmful danger and/or material damage will be signalled with a danger sign. To better characterize the danger, the symbol will be followed by one of these words:</p> <p>[1] DANGER: when there is the possibility of harm to the operator and/or people in the vicinity of the equipment [2] WARNING: when there is the possibility of material damage to the equipment and/or attached materials.</p>
	<p>All the information that the supplier believes to be an asset for better performance and preservation of the equipment, will be signalled together with the information sign.</p>

1.2 Safety Information

 WARNING/DANGER
<ul style="list-style-type: none"> • The electrical installation of the equipment must comply with the national regulations for electrical installations in effect. • The equipment can only work if the water heater is filled with water and properly purged; • The electrical supply is 230VAC/50Hz or 60Hz* (equipment version only designed on specific request); • The equipment must be connected to an electrical outlet with earth contact; • If the power supply cable is damaged, it must be replaced by the manufacturer, by its customer service, or by staff with similar training in order to avoid any danger. • Children must not play with the device. • Cleaning and maintenance must not be carried out by children without supervision. • This appliance can be used by children aged from 8 years and above and persons with reduced physical, sensory or mental capabilities or lack of experience and knowledge if they have been given supervision or instruction concerning use of the appliance in a safe way and understand the hazards involved. • The operating principle of this equipment is directly linked to high temperatures and pressures, so all processes that involve contact with the equipment must be prepared with care to avoid risks of burns and material projection. • The heating of other fluids than drinking water is not allowed.

1.3 Information



INFORMATION

Installation

- The installation of the equipment must be carried out by staff with suitable training and qualified for this purpose.
- The device **must not be** installed:
 - outdoors;
 - in places with corrosive environment;
 - in places with a risk of temperatures below 5°C;
 - in places that present a risk of impact, shock or explosion.
- The equipment must be installed in a dry place, protected from the weather;
- Keeping the equipment packed until the place and time of installation.
- Ensure that all hydraulic connections are properly watertight before powering the equipment electrically.
- The discharge pipe connected to the pressure limiting device must be installed in a non-freezing environment and continuously directed downwards.
- The discharge tube of the pressure limiting device must be kept open to the atmosphere.

Maintenance

- The user is responsible for the safety and environmental compatibility of the installation and/or maintenance.
- Maintenance/repair should only be carried out by a brand assistance service, with the exception of general and continuous cleaning operations, which can/must be carried out by the user himself. Repairs carried out incorrectly can create risks for the user and cause the product to malfunction.
- The supplier recommends that at least an annual inspection of the equipment be carried out by a qualified technician.
- Always switch off the electrical supply to the device before carrying out any maintenance work.
- Cleaning and maintenance must not be done by children without supervision.
- Only use original replacement parts.
- The safety valve must be operated regularly to remove impurities and check that it is not blocked.
- To drain the water from the water heater, close the supply valve and open the drain valve.

*** Pressure Reducing Valves**

- Pressures admitted upstream of the pressure reducing valve:
 - Maximum pressure allowed 1.2 Mpa;
 - Minimum pressure allowed 0.1 MPa;
- Pressure downstream of the pressure reducing valve:
 - Factory set to 0.3 MPa;

*** Safety Group**

The safety group allows the system to be protected in the event of anomalies in the supply of cold water, hot water return, emptying of the water heater and high pressures. The valve is calibrated to operate at 0.7 MPa.

Refrigerant

- Handle and recycle refrigerant gas, if necessary, in compliance with environmental laws. It cannot be released into the environment!
- The refrigerant gas is R134a, free of CFCs, non-flammable and without harmful effects on the ozone layer.
- Before carrying out any intervention on the components of the refrigerant circuit, evacuate/recover the refrigerant gas in order to carry out the operations safely.
- In maintenance, it must be taken into account that fluorinated greenhouse gas HFC-134a is used, covered by the Kyoto protocol GWP=1300.
- All gas handling must be carried out by a qualified technician.

In operation

- Water pressure:
 - Minimum 0,1 MPa;
 - Maximum 0,7 MPa;
- Water temperature:
 - Minimum 5 °C;
 - Maximum 65 °C;

Information to give to the customer

- The installer must inform the customer about the operation of the appliance, instruct him on its handling, and the customer's rights and duties.
- Communicate to the customer the fact that the alteration or maintenance of the device must only be carried out by specialized and accredited personnel.

(*)

Components not supplied with the equipment.
We strongly recommend its installation.



To request additional information, contact us via the email address energie@energie.pt or via our website www.energie.pt.

2 PACKAGE

2.1 Contents

The equipment is supplied in two packages: one package for the thermodynamic solar panel with fixing elements, and the other with the thermo-accumulator and the attached thermodynamic group.

The packages contain:

1. Thermodynamic solar panel with fastening elements;
2. Storage water heater;
3. Thermodynamic block;
4. Installation manual, warranty, energy label and product data sheet;
5. Security group;
6. Pressure reducing valve.

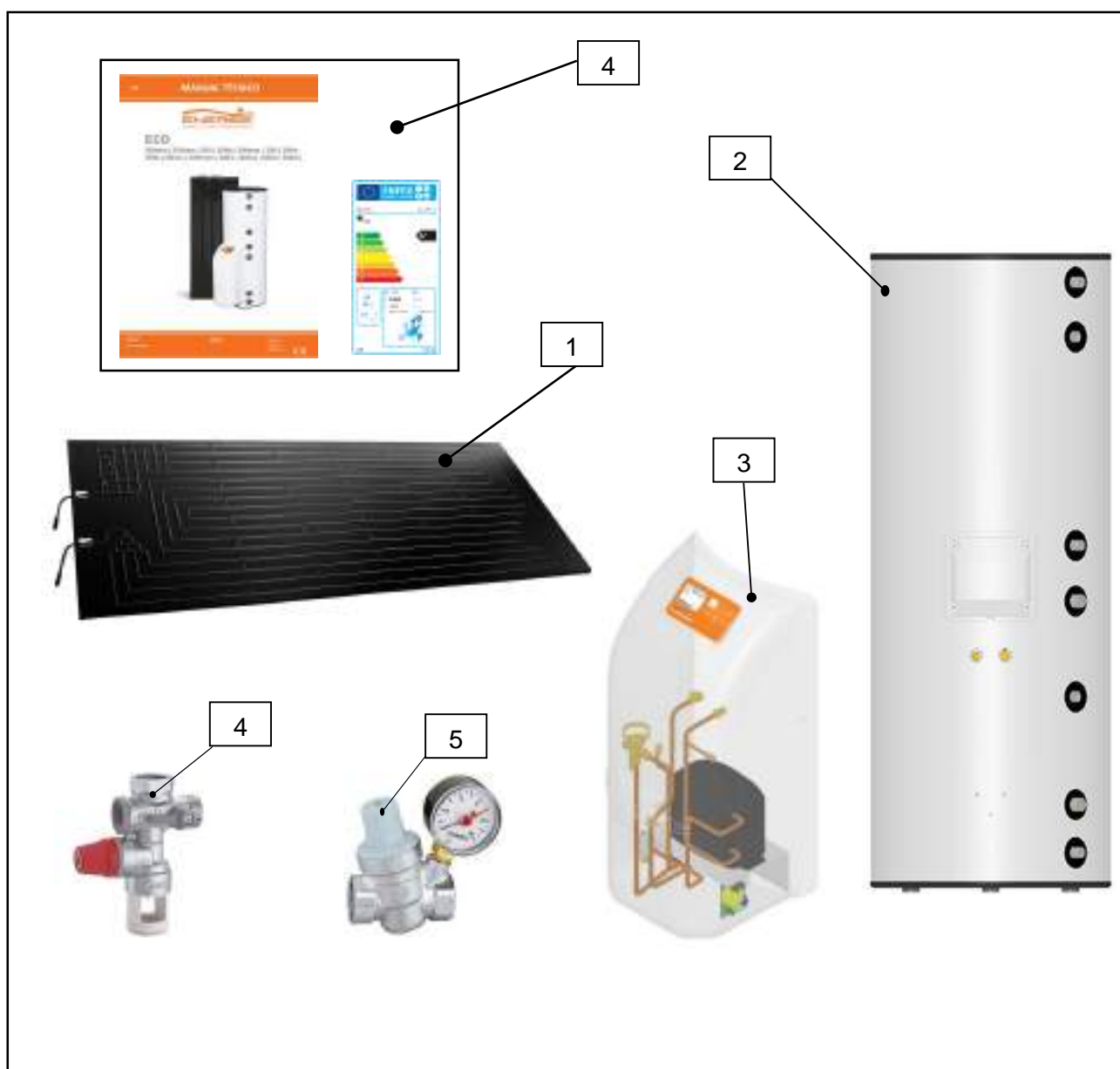

2.2. Transport





	<p>The equipment must be carried in an upright position. The equipment must be raised and lowered with extreme care, to avoid impact that could damage the material. Make sure the belts and/or transportation straps do not damage the material. Always use suitable means to transport the material (pallet lift, forklift, etc.)</p>
---	---



	<p>The transport of the equipment must be done with an inclination never exceeding 45°; Both the packaging containing the water heater and the thermodynamic block must be transported in an upright position and in the correct direction. Horizontal transport or with the equipment turned upside down can cause serious damage to the equipment.</p>
---	---

The equipment must always be transported in its original packaging, to the point of installation. Check, before starting the transport of the equipment, if the path you are going to take is unobstructed, in order to avoid collisions that could prove damage to the device.

The packaging contains the following information symbols:

	<p>Fragile, handle with extreme caution</p>		<p>Keep the package dry</p>
	<p>Make sure the arrows are always up</p>		<p>Do not stack packages</p>

3 SPECIFICATIONS

3.1 Running Principle

The Thermodynamic Solar System **ECO** is an equipment based on the principle of compression refrigeration - Carnot's principle - which we call the Thermodynamic Solar Systems: Solar Panel and a Heat Pump. The solar panel, which is the main component, placed outside ensures the capture of energy on:

- a) Direct and diffuse solar radiation;
- b) Outdoor air, by natural convection;
- c) The effect of the wind;
- d) Rain water.

The temperature difference caused by the mentioned external agents, guarantees that the R134a (ecological refrigerant) evaporates inside the solar panel.

The absence of glass on the panel allows to increase the thermal exchanges by convection.

After passing through the panel, the R134a is aspirated by the compressor, which raises its temperature and pressure, which in turn is transmitted to the water circuit through a condenser external to the tank.

Before the R134a returns to the solar panel, a choke must occur, that is, through a thermostatic expansion valve the pressure is reduced and the fluid reaches its liquid state again, thus completing the cycle.

This facility with which we combine technology with a law of nature (change of state of a fluid), demonstrates the veracity and potential of **ECO**.

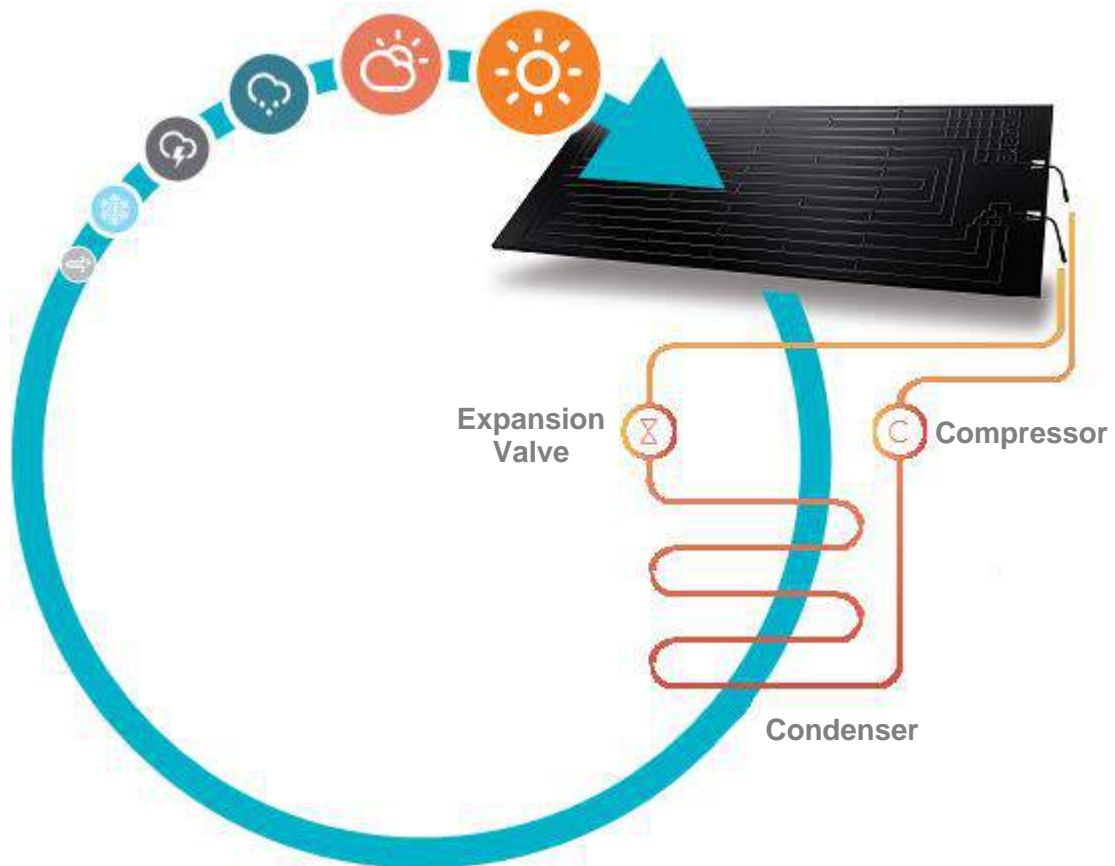

3.2 Technical Features (1 panel)

		Uni.	200i	250i / esm	300i / esm	250ix	300ix	
HOT WATER CYLINDER	Dry Weight	kg	40	45 / 83	50 / 95	52	57	
	Capacity	L	200	250	300	245	295	
	Water Heater Material	-	Stainless Steel	Stainless Steel / Enamelled		Stainless Steel		
	Cathodic Protection	-	Magnesium Anode (1"1/4 F) (if applicable)					
	Hydraulic Joints	Water – Inlet and Outlet	Pol.	3/4" Male				
		PT Valve		1/2" Female				
		Recirculation		3/4" Male				
		Coil Inlet e Outlet		1" Male				
	Insulation	-	High density polyurethane 50mm					
	Maximum Pressure	bar	7					
Maximum Pressure	°C	80						
Heat Loss (EN 12897)	kWh/24h	0,99	1,01 / 1,20	1,17 / 1,39	1,01	1,17		
Exchanger Output Power*	kW	-			a) 20 b) 12			
SOLAR PANEL	Material	-	Solar Coat Anodized Aluminium					
	Dimensions (L x A x E)	mm	2000 x 800 x 20					
	Weight	kg	8					
	Max Working Pressure	bar	12					
	Exposure Temperature	°C	-40 120					
THERMODYNAMIC BLOCK	Absorbed Power (Med/Max)	W	390 650					
	Thermal Power (Med/Max)	W	1400 2380					
	Electrical Backup Power	W	1500					
	Refrigerant / Qt.**	- / g	R134a / 1300					
	Piping Material	-	Copper (DHP ISO1337)					
	Line (Liq. Asp)	Pol.	1/4" 3/8"					
	Power Supply***	V / Hz	220-240 / Single phase / 50 or 60					
	Fuse (Main Electrical Heater)	A	10 10					
Working Temperature	°C	-5 45						
PERFORMANCE****	Tapping Profile	-	L	XL	XL	XL	XL	
	Coefficient of Performance (COP)	Air 2°C	-	2,8	2,9	2,9	2,9	2,9
		Air 7°C	-	3,1	3,2	3,3	3,2	3,3
		Air 14°C	-	3,6	3,8	3,7	3,8	3,7
	Energy Efficiency ErP Class	Air 2°C	-	A+	A	A	A	A
		Air 7°C	-	A+	A+	A+	A+	A+
		Air 14°C	-	A++	A+	A+	A+	A+
	Energy Efficiency	Air 2°C	%	118	121	119	121	119
		Air 7°C	%	132	132	137	132	137
		Air 14°C	%	154	155	151	155	151
	Annual Energy Consumption	Air 2°C	KWh/ano	869	1389	1411	1389	1411
		Air 7°C	KWh/ano	774	1268	1227	1268	1227
		Air 14°C	KWh/ano	664	1078	1111	1078	1111
Mixed Water at 40°C	L	247	349	389	342	382		
Default Setpoint	°C	53						
Sound Power Level Indoor	dB	47						

* a) Primary circuit (Tin =90 °C; Tout =80 °C); Production DHW (Tin=10 °C; Tout=60 °C)

b) Primary circuit (Tin =70 °C; Tout =60 °C); Production DHW (Tin=10 °C; Tout=60 °C)

** The amount of fluid must be checked by the installer. In some cases it is necessary to add or remove fluid in order to ensure the correct running of the system.

*** The frequency of 60Hz is a version of the equipment produced only by specific request.

**** According to EN16147, Delegated Regulation (EU) N° 812/2013 and Delegated Regulation (EU) N° 844/2013, for the three climatic zones: colder (20C), medium (70C) and warmer (140C).

3.3 Technical Features (2 panels)

		Uni.	200is	250is	300is/esm	250isx	300isx	500is	500isx	
HOT WATER CYLINDER	Dry Weight	kg	40	45	50/95	52	57	73	93	
	Capacity	L	200	250	300	245	295	455	443	
	Water Heater Material	-	Stainless Steel	Stainless Steel	Stainless Steel / Enamelled	Stainless Steel				
	Cathodic Protection	-	Magnesium Anode (1"1/4 F) (if applicable)							
	Hydraulic Joints	Water – Inlet and Outlet	Pol.	3/4" Male				1" Male		
		PT Valve		1/2" Female				1/2" Male		
		Recirculation		3/4" Male						
		Coil Inlet e Outlet		-	1" Male		-	1" Male		
	Insulation	-	High density polyurethane 50mm							
	Maximum Pressure	bar	7							
Maximum Pressure	°C	80								
Heat Loss (EN 12897)	kWh/24h	1,04	1,01	1,17/1,39	1,01	1,17	1,81	1,81		
Exchanger Output Power*	kW					a) 20 b) 12	-	a)54,2 b)12		
SOLAR PANEL	Material	-	Solar Coat Anodized Aluminium							
	Dimensions (L x A x E)	mm	2000 x 800 x 20							
	Weight	kg	8							
	Max Working Pressure	bar	12							
	Exposure Temperature	°C	-40 120							
THERMODYNAMIC BLOCK	Absorbed Power (Med/Max)	W	620 950							
	Thermal Power (Med/Max)	W	2300 3760				2300 4500			
	Electrical Backup Power	W	1500				2200			
	Refrigerant / Qt.**	- / g	R134a / 1300							
	Piping Material	-	Copper (DHP ISO1337)							
	Line (Liq. Asp)	Pol.	3/8" 1/2"							
	Power Supply***	V / Hz	220-240 / Single phase / 50 or 60							
	Fuse (Main Electrical Heater)	A	10 10							
	Working Temperature	°C	-5 45							
PERFORMANCE****	Tapping Profile	-	L	XL	XL	XL	XL	XXL	XXL	
	Coefficient of Performance (COP)	Air 2°C	-	2,76	2,8	2,8	2,8	2,8	2,9	2,9
		Air 7°C	-	3,09	3,2	3,1	3,2	3,1	3,3	3,3
		Air 14°C	-	3,55	3,7	3,7	3,7	3,7	3,5	3,5
	Energy Efficiency ErP Class	Air 2°C	-	A+	A	A	A	A	A	A
		Air 7°C	-	A+	A+	A+	A+	A+	A+	A+
		Air 14°C	-	A++	A+	A+	A+	A+	A+	A+
	Energy Efficiency	Air 2°C	%	116	117	116	117	116	118	118
		Air 7°C	%	130	132	130	132	130	132	132
		Air 14°C	%	151	152	151	152	151	139	139
	Annual Energy Consumption	Air 2°C	KWh/ano	885	1438	1447	1438	1447	1823	1823
		Air 7°C	KWh/ano	786	1272	1300	1272	1300	1638	1638
		Air 14°C	KWh/ano	679	1103	1112	1103	1112	1553	1553
Mixed Water at 40°C	L	247	349	389	342	382	599	592		
Default Setpoint	°C	53								
Sound Power Level Indoor	dB	47								

* a) Primary circuit (Tin =90 °C; Tout =80 °C); Production DHW (Tin=10 °C; Tout=60 °C)

b) Primary circuit (Tin =70 °C; Tout =60 °C); Production DHW (Tin=10 °C; Tout=60 °C)

** The amount of fluid must be checked by the installer. In some cases it is necessary to add or remove fluid in order to ensure the correct running of the system.

*** The frequency of 60Hz is a version of the equipment produced only by specific request.

**** According to EN16147, Delegated Regulation (EU) N° 812/2013 and Delegated Regulation (EU) N° 844/2013, for the three climatic zones: colder (20C), medium (70C) and warmer (140C).

3.4 Main Components

3.4.1 General Diagram of Assembly

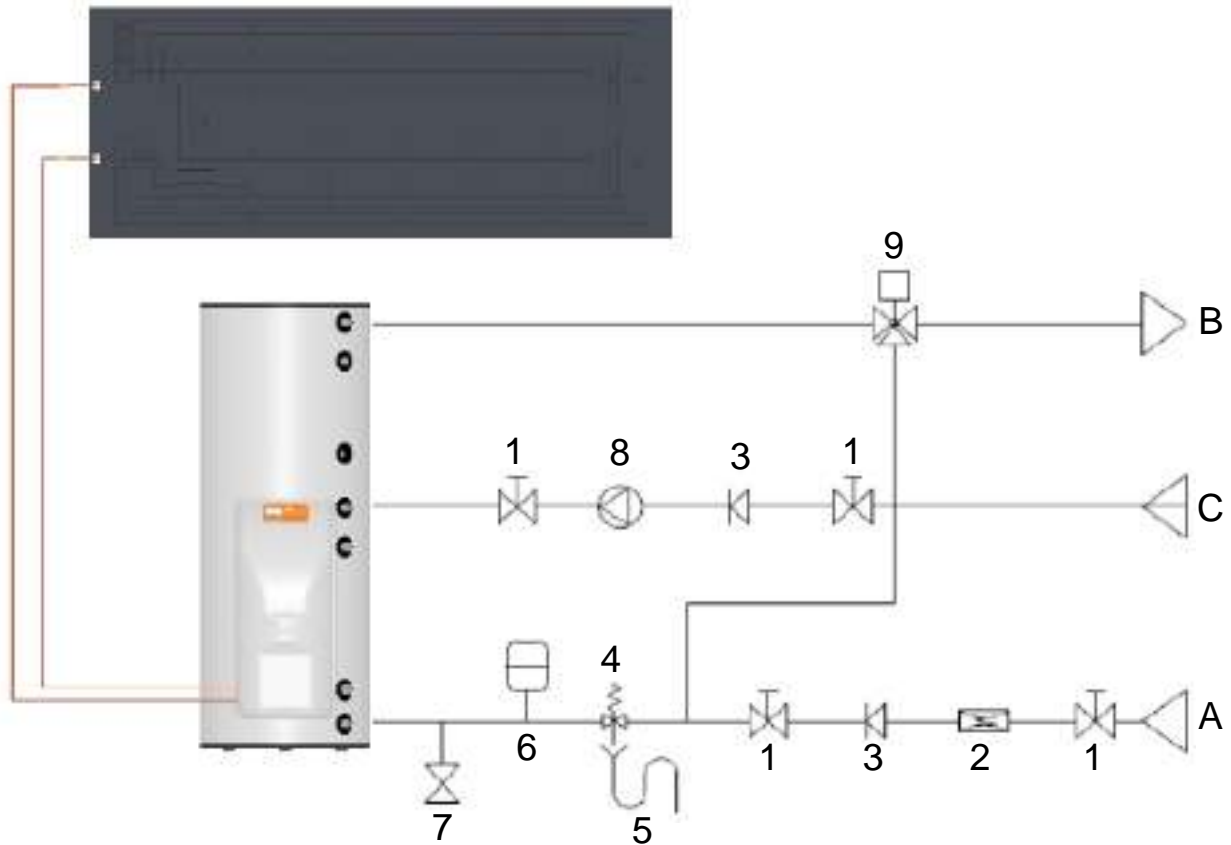

CAPTION

- | | |
|---|-----------------------------|
| 1 Shut Off Valve | 7 Drain Valve |
| 2 Pressure Reducing Valve (3 bar / 0,3 MPa) | 8 Circulation Pump |
| 3 Non-return Valve | 9 Thermostatic Mixing Valve |
| 4 Safety Group (7 bar / 0,7 MPa) | A Cold Water Inlet |
| 5 Drainage Siphon | B Hot Water Outlet |
| 6 Expansion Vessel | C Recirculation |



It is necessary to install a safety device at the cold water inlet of the appliance. The safety device must be in compliance with the standard EN 1487:2002, maximum pressure 7 bar (0.7 MPa) Water must not be stopped from flowing from the safety device to the deposit by any sort of accessory. The safety device must be connected with piping whose diameter is not less than the cold water inlet coupling. The discharge must be connected to a sewage siphon or, if this is not possible, elevated to a distance of at least 20 mm from the pavement to allow visual inspection; To prevent high pressure from main water supply, install a pressure reduction valve set to 3 bar (0.3 MPa).

3.4.2 Dimensions

Thermodynamic Solar Panel



Interior Unit

ECO 200I | ECO 250I/IX
Front hydraulic connections

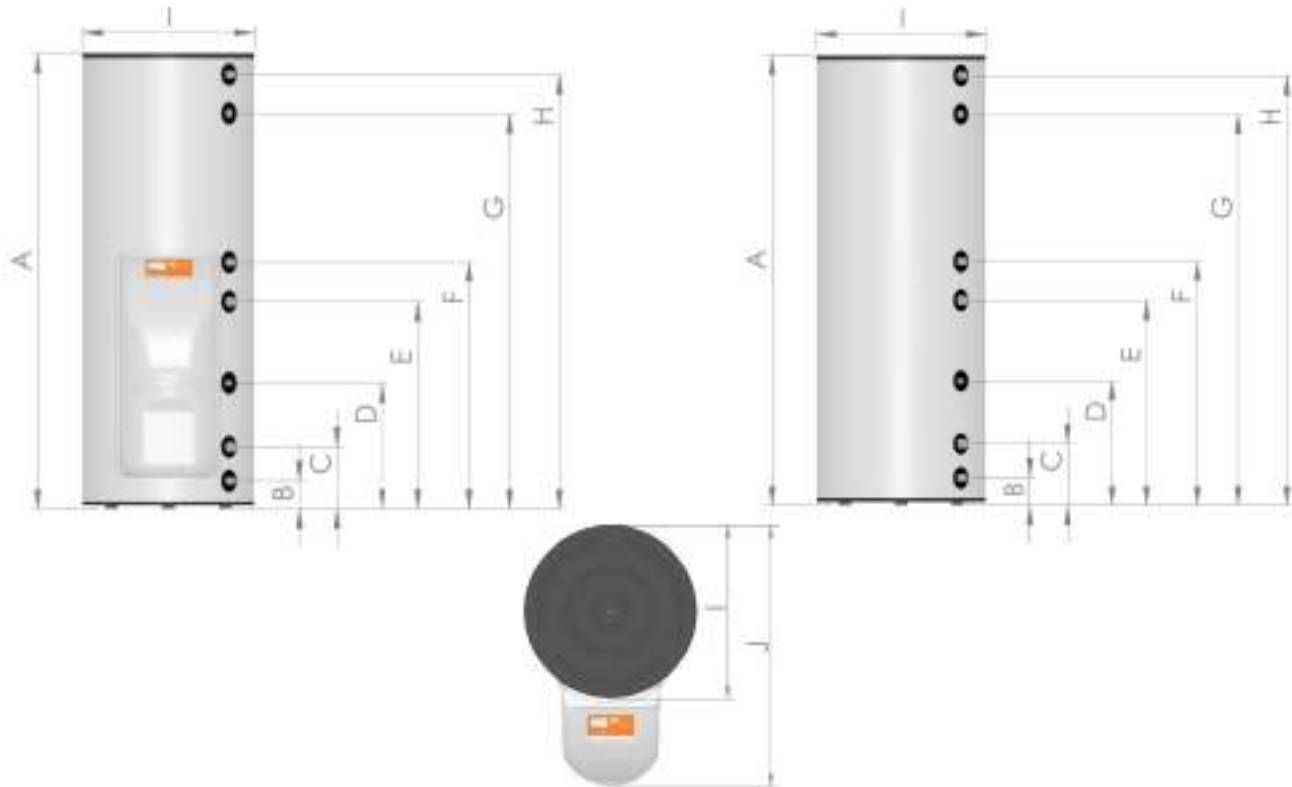

ECO 250esm | 300esm/I/IX | ECO 500I/IX
Rear hydraulic connections



	Ø Pol.	200 i mm	250 esm mm	250 i/ix mm	300 esm mm	300 i/ix mm	500 i/ix mm	Obs. -
A	-	1240	1540	1540	1430	1400	2020	-
B	G 3/4" M	131	99	131	102	107	102	Cold Water
C	G 1" M	-	-	231	-	236	635	Coil Outlet
D	-	-	-	435	-	436	-	Instrumentation
E	G 1" M	-	-	690	-	636	1525	Coil Inlet
F	G 1/2" F	-	840*	840	782*	855	782	Recirculation
-	G 1 1/4" M	-	1025	-	1096	-	1093	Magnesium Anode
G	G 1/2" F	905	1351	1205	1182	1065	1770	PT Valve
H	G 3/4" M	1030	1477	1325	1325	1190	1937	Hot Water
I	-	Ø 580	Ø 580	Ø 580	Ø 650	Ø 650	Ø 650	-
J	-	875	875	875	945	945	945	-

*G 3/4" M

3.4.3 ID Plate

 ENERGIE [®] THERMODYNAMIC SOLAR ENERGY	
MODELO MODEL	ECO 250 I / IS
Nº SERIE SERIAL N.	71252000126
DATA PROD. PROD. DATE	06.05.21
Volume Capacity	250 L
Peso Weight	45 kg
Pressão Máxima de Trabalho Max Tank Pressure	0,7 MPa / 7 bar
Temperatura Máxima Agua Max Water Temperature	80 °C / 176 F
Contém gases fluorados com efeito de estufa abrangidos pelo Protocolo de Quioto Contains fluorinated greenhouse gases covered by the Kyoto Protocol Contient des gaz à effet de serre fluorés relevant du protocole de Kyoto	
Deverá ser instalado um dispositivo limitador de pressão A pressure relief device should be installed Un dispositif limiteur de pression doit être mis dans l'installation	
 71252000126	
 MADE IN PORTUGAL	



SAÍDA ÁGUA QUENTE
HOT WATER OUTLET

VÁLVULA PT*
PT VALVE*

ÂNODO Mg
Mg ANODE

RECIRCULAÇÃO
RECIRCULATION

ENTRADA ÁGUA FRIA
COLD WATER INLET

*OPCIONAL/OPTIONAL

Mod. 103.3



Any contact with the installer or manufacturer must be accompanied by:

- Model;
- Serial number;
- Date of production.

The provision of these data will facilitate all communication and consequently a faster and more correct response.

3.4.4 Thermodynamic Solar Panel

The thermodynamic solar panel, responsible for the process of evaporation of the fluid, is made of aluminium, with post-pressing anodic oxidation that gives it a black appearance. There are two types of panels: left and right (designated by the connection side):

Left Panel



Right Panel



The panels have the following pipe diameters:

- 3/8" aspiration (upper joint)
- 1/4" liquid (lower joint)

In the case of panel equipment, the refrigerant connections are of the conical threaded type (Flare SAE):

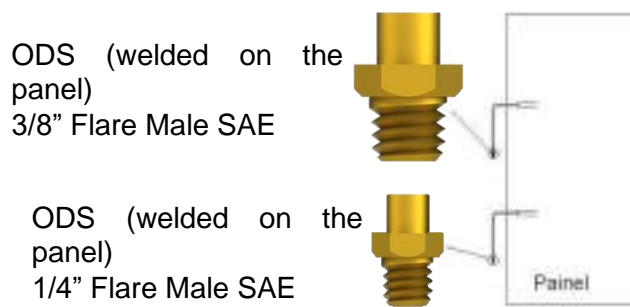

For each panel, the elements supplied are:

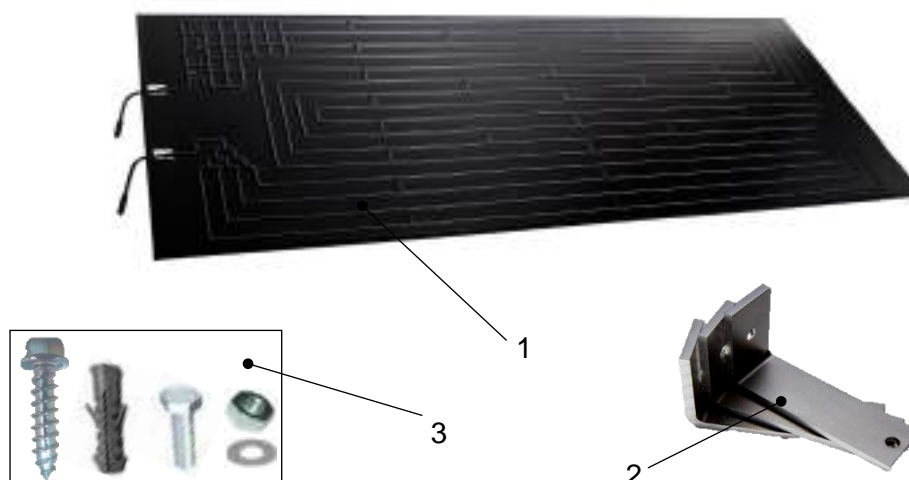

- 1) Thermodynamic Solar Panel;
- 2) Aluminium L-shaped for attachment of Thermodynamic Solar Panel (6x ou 12x);
- 3) Fixing elements.

3.4.5 Thermodynamic Block + Storage Water Heater

Thermodynamic Block

We call the Thermodynamic Block to the components based on a galvanized steel structure, which contains two of the main elements for the operation of the thermodynamic cycle: compressor and expansion valve.

On the side of the block there are 2 and 3 way valves for connection to the panel (3/8 " - Aspiration; 1/4 " - Liquid).

This Thermodynamic Block is coupled to the water heater through three M8 screws and connected to the condenser, which surrounds the water heater, through two One-Shot valves.

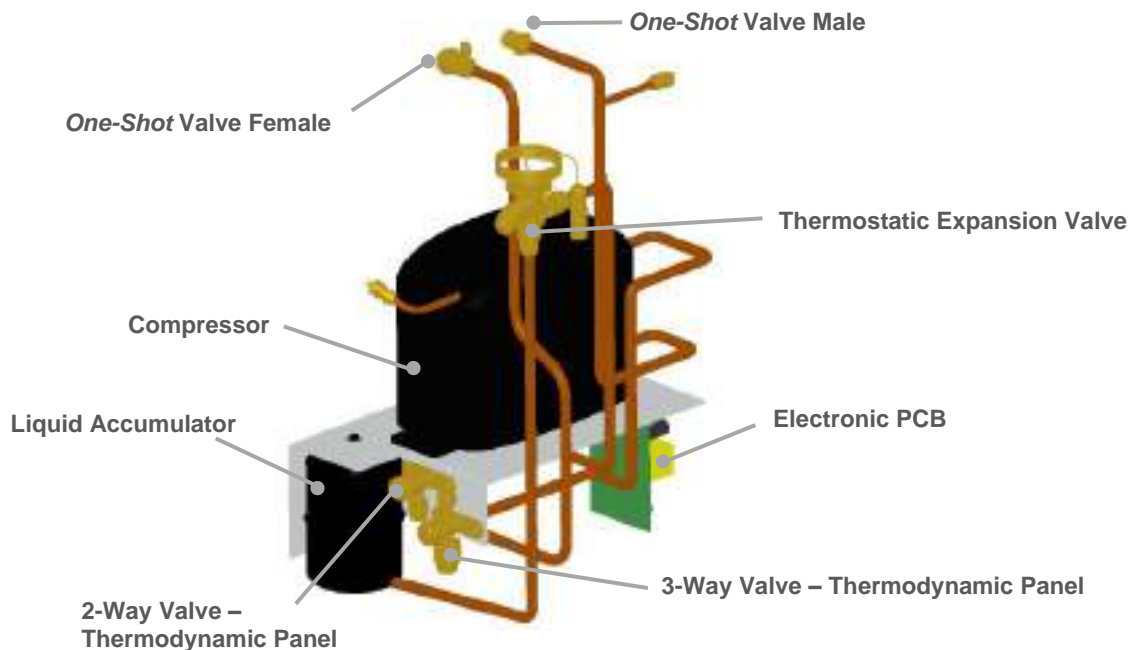

Storage Water Heater

The domestic hot water storage heater is vertical, resting on the ground. Thermal insulation is done by means of high density polyurethane.

The water heater had:

- Cold water inlet;
- Hot water outlet;
- Recirculation;
- Pressure and temperature valve / instrumentation;
- Magnesium anode (joint 1 1/4" F) (if applicable);
- Possibility of integrating support coil (joint 1 "M);
- Electrical heater;
- Safety thermostat;
- Temperature probe.



3.4.6 Refrigerant

R134a is an HFC refrigerant, and as such, it is not harmful to the ozone layer. They have great thermal and chemical stability, low toxicity, are not flammable and are compatible with most materials. The following table lists the evaporation temperature with the pressure:

T (°C)	P (bar)	T (°C)	P (bar)
-20	0,33	20	4,70
-15	0,64	25	5,63
-10	1,00	30	6,70
-5	1,43	35	7,83
0	1,92	40	9,10
5	2,49	45	10,54
10	3,13	50	12,11
15	3,90	55	13,83

3.5 Safety and Control Devices

3.5.1 Low Pressure Switch

In case of running outside the range of pressures recommended and defined by the supplier, the equipment will switch off and indicate error in the electronic panel.

3.5.2 Safety Thermostat

The safety thermostat is set by the supplier to ensure that the water temperature in the storage water heater does not exceed the standard value. If the temperature exceeds this value, the thermostat switches off the backup electrical heater. Switching on is done manually by qualified staff, after analysing the reasons for the switch off.

3.5.3 Temperature Probe

The purpose of the temperature probe is to measure the temperature values of water in the storage water heater in order to control the system.

3.5.4 Protection Against Corrosion (if applicable)

Besides being resistant to corrosion (stainless steel), the storage water heater has in addition a magnesium anode that should be checked periodically according to information by the installer.

3.5.5 Dielectric Joint (enamelled boilers)

If the boiler is made of enamelled steel, the equipment contains two dielectric bushings. These bushings prevent electrons from exchanging between the water inlet and outlet tubes and the water heater itself. In this way, another protection against corrosion is created, which could be verified especially in these points.

Thus, the bushings (A) must be tightened on the inlet (B) and water outlet (B) connections of the tank, before placing the respective tubing (C).



3.5.6 Expansion Vessel*

The expansion vessel is a device whose purpose is to compensate for the increase in water volume due to temperature rise.

	<p>The placement of this device is a recommended procedure for the correct installation of the equipment.</p> <p>The installation of this device is the responsibility of the installer. The absence of this device will void the warranty. As a general rule it is installed in the cold water pipe.</p>
---	---

3.5.7 Safety Group

The safety device allows the system to be protected against anomaly situations: cold water supply, hot water flowing back, emptying of the storage water heater and high pressure. The valve is calibrated to activate at 0.7 MPa).

To drain the water in the storage water heater, you should close the supply valve and open the discharge valve.

The safety valve discharge pipe must be open into the atmosphere, because the valve may drip water or even discharge water.

The safety valve must be opened regularly to remove impurities and check that it is not blocked. The discharge pipe must be installed in a vertical position. The discharge pipe must be installed upright away from a cold environment.

	<p>The placement of this device is a mandatory procedure for the correct installation of the equipment.</p> <p>The installation of this device is the responsibility of the installer. As a general rule it is installed in the cold water pipe.</p>
--	---

3.5.8 Pressure Reducing Valve

The pressure reducing valve must always be installed upstream from the safety device, and ready to activate in situations when the pressure in the circuit exceeds 3 bar (0.3MPa). This valve comes with a pressure gauge.

	<p>The installation of the pressure reducing valve must take into account the correct direction of the hydraulic flow.</p> <p>The correct direction is represented by an arrow on the component itself.</p> <p>Incorrect installation poses a danger to equipment and people.</p>
---	---

***Parts not supplied by the manufacturer. They must be installed by the installer.**

4 INSTALLATION

Assembly sequence:

- | | |
|--|---------------------------|
| a) Thermodynamic solar panel fixing | e) Electrical connections |
| b) Placement of the cylinder + thermodynamic block | f) Nitrogen load |
| c) Refrigerant connections | g) Leak verification |
| d) Hydraulic connections | h) Vacuum |
| | i) Installation start-up |

	<p>The unit is preloaded for a maximum connection length of up to 12 meters (horizontal) between the panel and the water heater. Longer distances decrease the performance of your equipment.</p>
--	--

4.1 Attachment of the Panel

The nature of the site and the inclination angle where the panels are installed are important factors to take into account. In order to benefit the most from the sunlight exposure, the panels should have a pitch between 10° and 85° relative to the horizontal plane, and preferably oriented to the south.

The panel already comes with 6 holes for M8 in the lateral skirts. The distance between holes in the place where the panel rests, should coincide with the holes made in the panel.

	<p>Attachment to at least 6 points (3 upper points and 3 lower points) is mandatory!</p> <p>The lack of at least one of these points can cause deformations in the panel and in some cases the displacement of the panel from the installation site.</p> <p>In very windy areas or climatic conditions conducive to bad weather, it is advisable to fix the panels at more points.</p>
--	---

Fixing the Aluminium Profiles:

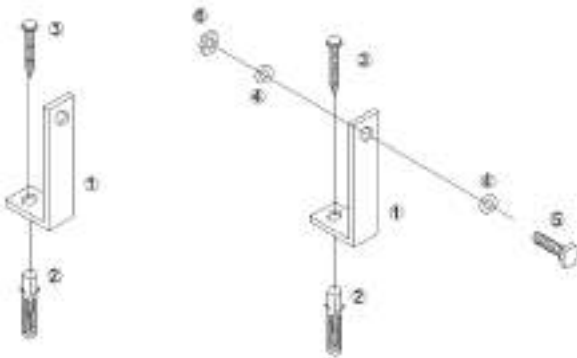

- 1 Aluminium profile
- 2 Plastic bushing
- 3 Self-tapping screw M6x40
- 4 Washer M6
- 5 Screw M6x20
- 6 Nut M6
- 7 Panel

Fixing the aluminium profiles and the panel:

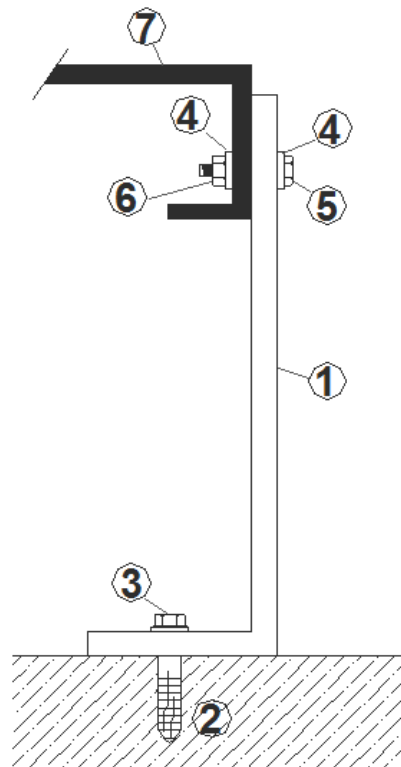

The system has 3 small profiles (side A) and 3 large profiles (side B) that must be fixed as shown in the image, giving the panel a desirable inclination.

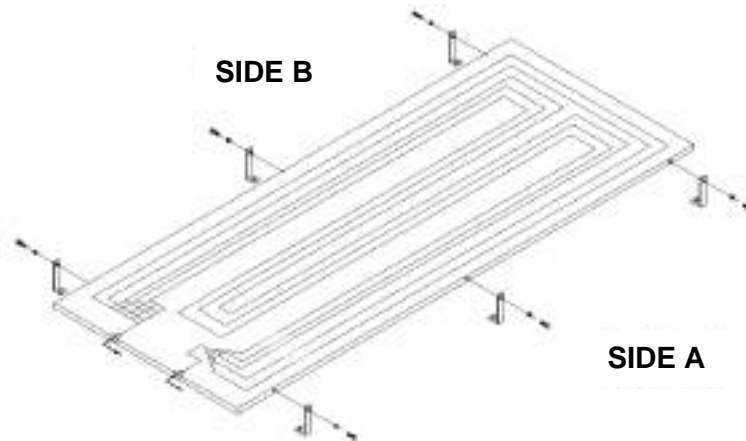

If the panel is to be installed in a climatic zone conducive to snowfall, the panel must be installed with a minimum slope of 45°!

The profile must be fixed to the base (eg tile) using a plastic anchor and M6 screw provided. The panel is fixed to the profiles using the M6 screws and the respective nuts and washers. The panel packaging has a marking that can serve as a guide to guide the holes in the base. This marking follows the following figure:

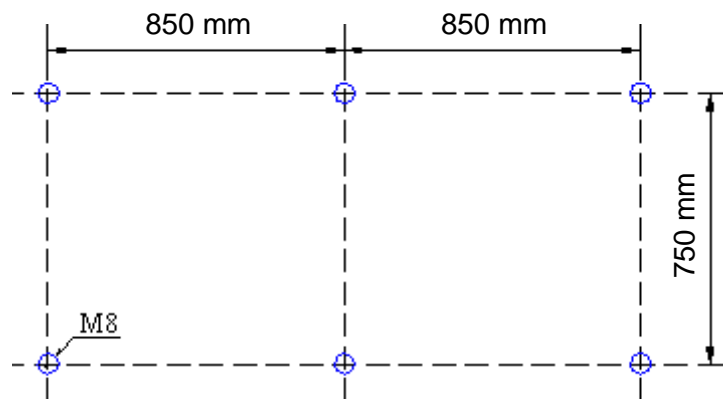

**WARNING
DANGER**

The panel must always be installed with the connections facing downwards.

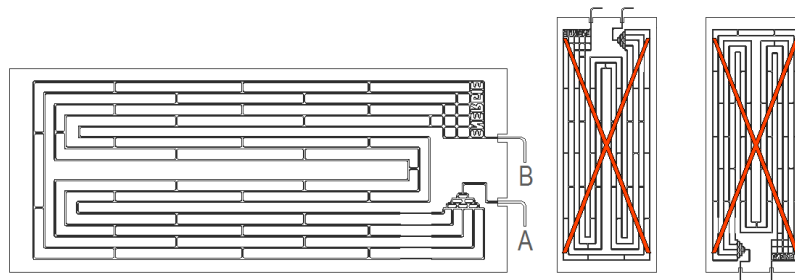

- **A** – Liquid inlet
- **B** – Vapour outlet (aspiration)

4.2 Positioning

Preliminary considerations:

- House and protect the equipment in places susceptible to ice formation;
- Choose the position closest to the main points of use;
- Always insulate the pipes;
- The ambient temperature around the equipment must not exceed 40 ° C;
- The water heater should never be placed outside, also avoiding exposure to sunlight - failure to respect this parameter can lead to the exclusion of the warranty;
- Make sure that the support surface is sufficient to accommodate the weight of the water-filled water heater;
- Provide at least 500mm of space on the fronts that may require maintenance.

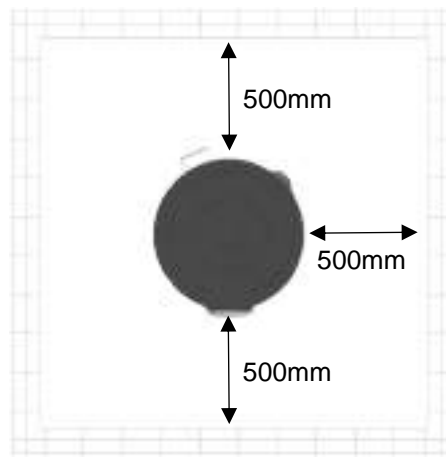

4.3 Installation of Thermodynamic Block

When assembling the thermodynamic block, must:

- a) Tighten the three M8 bolts (**A**), in the storage water heater;



Do not fully tighten the screws, so that it is easy to insert the thermodynamic block, giving the final tightening only after inserting the block in the water heater.

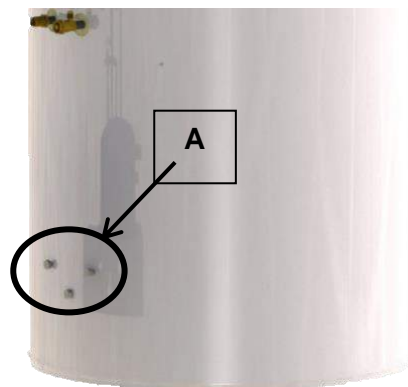

b) Aim the metallic structure with the orifices to the three M8 bolts previously mentioned.



c) Set the structure, gently on the screws, adjusting the final tightening of the same;

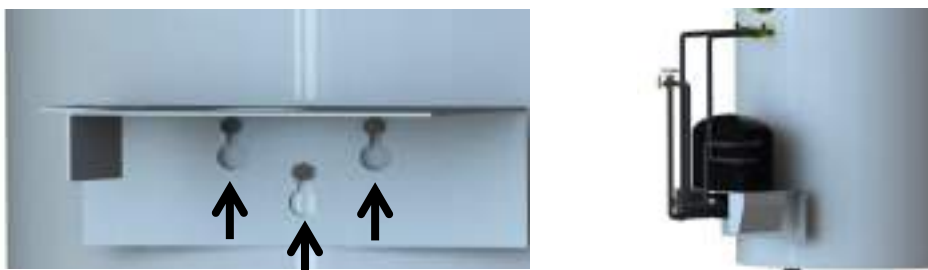

4.4 Refrigerant Connections

Diameter of the Pipes		
N° panels	Vapour (aspiration)	Liquid (panel inlet)
-	Inches	Inches
1	3/8"	1/4"
2	1/2"	3/8"

 WARNING DANGER	<ul style="list-style-type: none"> • Refrigerant connections must be made by a qualified technician, with a professional certificate of capabilities for the purpose. • Refrigerant connections must be thermally insulated to prevent burns and to ensure optimum system performance. • The system has an R134a fluid preload.
--	--

4.4.1 Connections to the panel

1 Thermodynamic Panel

- Prepare the copper pipe, removing the protective caps from the extremities.
- Place the extremity of the pipe upside down, cut the appropriate size of pipe and sand the rough edge.
- Remove the females from the connections to the panel and place them on the side of the tube.



- Flange the tube with the appropriate tool shaping a conic edge, taking care that there should be no burrs or imperfections and the length of the walls must be uniform.

e) Squeeze the female with your hand, taking a few turns.

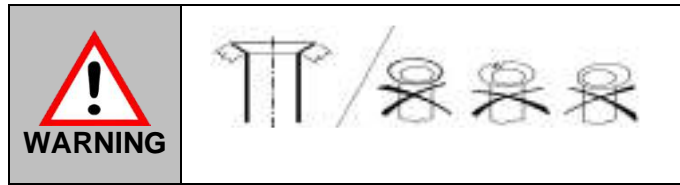

i It is recommended to use thread sealant, appropriate for the purpose! The sealant must be placed between these two steps [e); f)]. If in doubt, consult the manufacturer.

f) Give the final tightening by applying a twisting pair of values as indicated in the table;

i		
Diameter of the pipe (inches)	Applied Torque (Nm)	Wrench N°
1/4"	14 to 16	19
3/8"	33 to 42	21

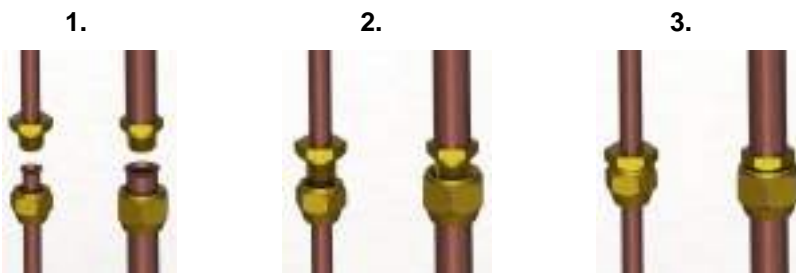

2 Thermodynamic Panels

- a) Prepare the copper pipe, removing the protective caps from the extremities.
- b) Place the extremity of the pipe upside down, cut the appropriate size of pipe and sand the rough edge.
- c) Then remove the covers from the panel connections and, using a sharp object, remove 5cm of heat-shrink tubing from them;

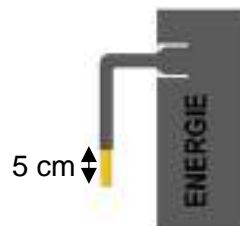

d) Using the appropriate tool, must be made the tube expansion (3/8") suitable for connection to the panel.



- e) Aim the liquid and suction tubes and before starting the welding operation, you must protect the heat-shrink tubing (you can use a damp cloth);



The type of solder recommended for welding the pipes is type oxyacetylene (Oxygen/ Acetylene). Other types of gases can also be used, such as propane for example.

- f) After welding the panel connections and before installing the equipment, make sure the apparatus has been cleaned with nitrogen.



For installations of two or more panels, it is essential that the refrigerant is distributed evenly (**Panel inlet**). For this purpose, the equipment is already accompanied by a liquid distributor. This distributor is placed between the two panels. **The pipes connecting the panels (1/4 ") must be exactly the same length**, and their ends connect directly to the panels.

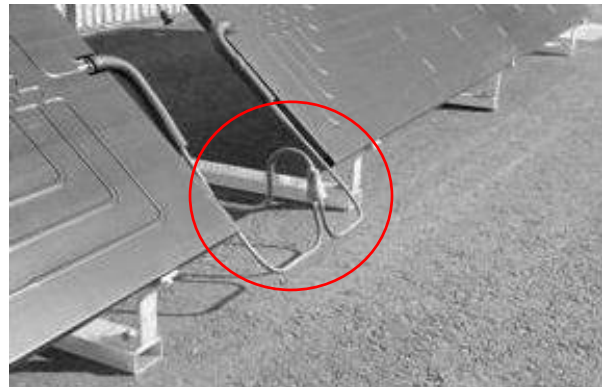
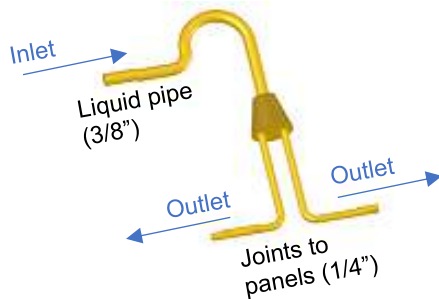

For installations of two or more panels, it is essential that the refrigerant is distributed evenly (Panel inlet). For this purpose, the equipment is already accompanied by a liquid distributor. Regarding the suction connections (Exit of the panels), the same symmetry accuracy in the length of the tubes is not required. The same should be done by "chipping" or with a "T" (as shown in the following image), properly isolated.

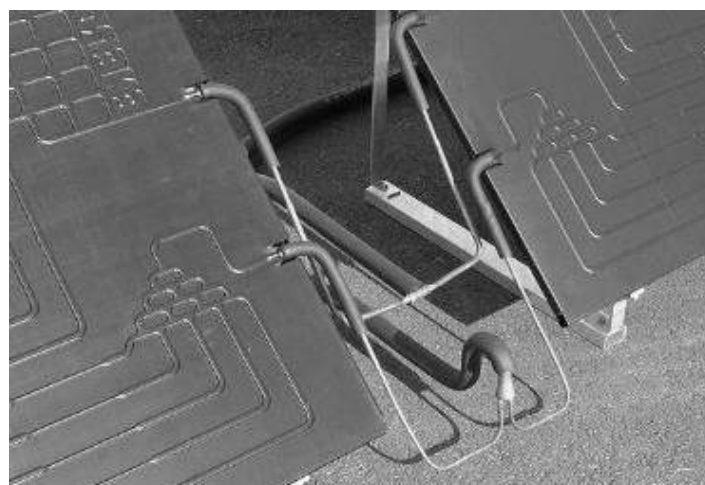

4.4.2 Connection of thermodynamic block to the storage water heater

After securing the thermodynamic block to the storage water heater with its bolts, we can proceed with making the refrigeration couplings between the block and the storage water heater.

- a) Remove the protection caps from the One-Shot valves on the pipes of the condenser and thermodynamic block.



- b) Tighten the valves with your hand making a few turns.



- c) Tighten with a suitable wrench, applying a torque in conformity with the diameter of the pipe employed (according to table in point 4.4.1). Insufficient torque will cause leaks of refrigerant. Excessive torque on the coupling will damage the edge of the pipe and cause leaks.



4.4.3 Connection of thermodynamic block and panel



Some of the steps to be carried out are the repetition of the procedures carried out in connection to the panel.

- a) Cut the tube to the required size with the end facing down. Clean existing burrs;
- b) Taper the tube, not forgetting to place the female on the side of the tube;
- c) Squeeze the female with the hand, taking a few turns;



It is recommended to use thread sealant, appropriate for the purpose! The sealant must be placed between these two steps [c); d)]. If in doubt, consult the manufacturer.

d) Tighten with the appropriate wrench using the torque pair seen in the previous subchapter.

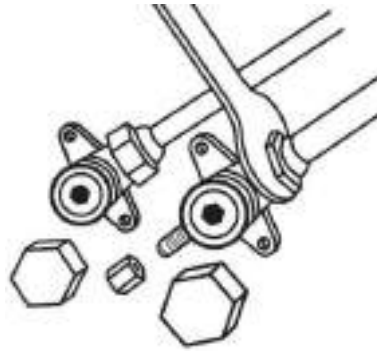

It is important to keep the valves closed to proceed to the following points.
 The water heater + thermodynamic group is filled with fluid.
 The closed valves ensure that the fluid does not escape during the next steps.

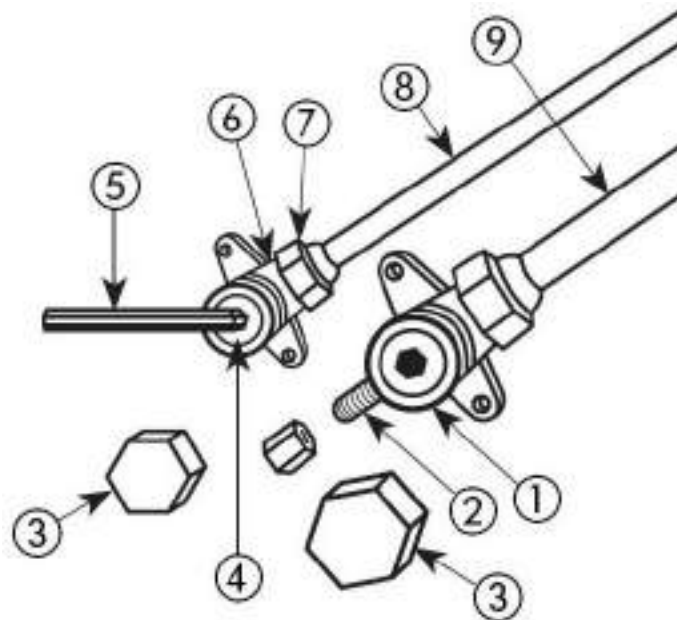

- | | | | |
|---|----------------------------------|---|------------------------------|
| 1 | 3-Way-Valve | 6 | 2-Way-Valve |
| 2 | Pressure intake | 7 | Conic nut |
| 3 | Valve socket | 8 | Liquid line (small diameter) |
| 4 | Valve needle | 9 | Gas line (large diameter) |
| 5 | Hexagonal tip wrench (Allen Key) | | |



All connections must be isolated!

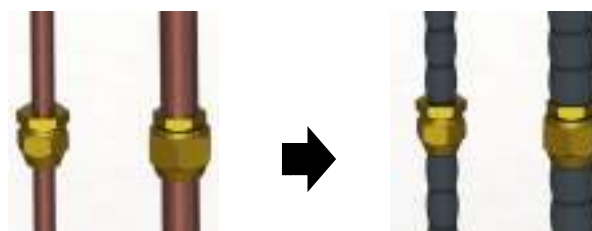

4.4.4 Load of Nitrogen

- a) After finishing the couplings, make sure there are no leaks. For this purpose, inject a load of nitrogen with a pressure of 10 bar through the pressure inlet (3-way valve).
- b) Brush every coupling in soap foam and make sure that the pressure in the pressure gauge is constant.

4.4.5 Vacuum

- a) During the whole procedure, employ, connections, vacuum pump and pressure gauges suitable for fluid R134a.
- b) Employ a vacuum pump only to remove the air and humidity inside the piping.
- c) Never use the system coolant to purge the connection pipes.
- d) The valves must be completely shut during the vacuum process, in order to create vacuum only in the piping.

Closed Valves

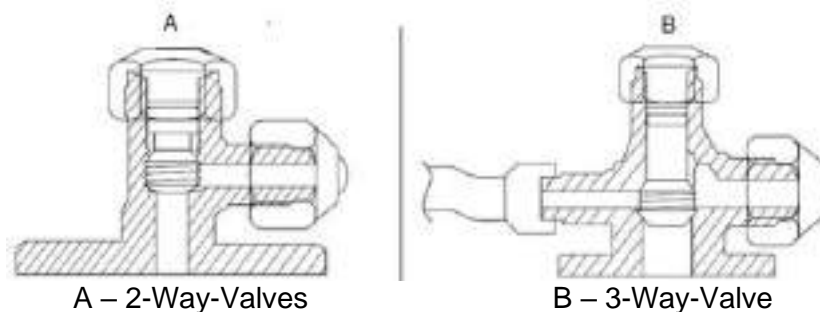

- e) Create a vacuum with the vacuum pump plugged to the inlet of the 3-way pressure valve as depicted, keeping the valves completely shut. The vacuum should be at least 30min for installation of one panel and 45min for installation of two panels;
- f) Once the vacuum procedure is over, shut the vacuum pump valves. The vacuum pressure gauge should indicate the same reading after the pump has stopped, ensuring the installation is in a vacuum and ready for running the coolant;
- g) After concluding the vacuum procedure, you must open the two valves so that the coolant may circulate throughout the whole system; the installation keeps the vacuum steady and is ready for running the coolant;
- h) Remove hose connected to 3-way valve.

Open Valves

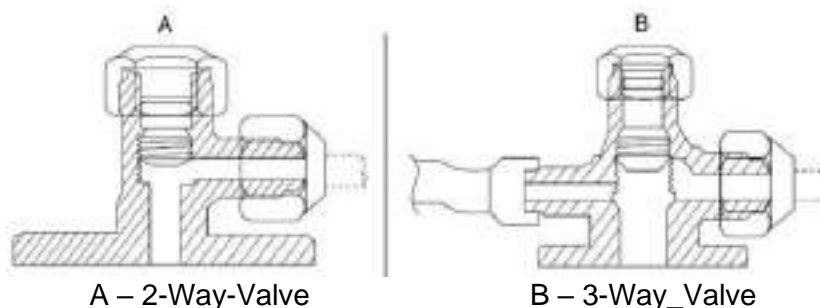

	<p>After vacuuming, do not remove the hoses until the system is fully pressurized by the refrigerant. This prevents atmospheric air (atmospheric pressure) from entering the system (vacuum).</p>
---	---

4.4.6 Checking good running condition

To check whether your equipment is running correctly, start it and wait at least 30 minutes and then check these conditions:

- Super-heating, without solar radiation directly over the panel, should be within the range 5°C to 10°C (Super-heating = $T_{\text{suction}} - T_{\text{evaporation}}$);
- The gradient between the gas temperature at the condenser inlet and the condensation temperature must be within the range 16°C to 20°C.

4.4.7 Load of complementary refrigerant (if necessary)

Your unit has been pre-loaded for connections up to 12m (horizontal) between the panel and the storage water heater. Longer distances will decrease the performance of your equipment.

Before carrying out an additional load of gas into the equipment, must prepare all the equipment and tools necessary for the operation, such as:

- Gas bottles and their hoses
- Hexagonal-tip wrench to open the 3-way valve
- Scale with precision of 10 g

To carry out a complementary load of gas, follow these steps:

- Place the cooling fluid tank on a scale with a 10 g precision and take note of the weight;
- Connect the hose of the cooling fluid tank (R134a) to the inlet of the 3-way valve;
- Switch off the compressor on the electronic panel;
- Open carefully and only slightly the handle of the cooling fluid tank, notice the variation of the figure indicated in the scale (as you load fluid into the circuit, the figure for the weight in the scale will decrease);
- When you reach the figure intended for the injection of cooling fluid into the circuit, close the tank handle and remove the hose connected to the 3-way valve;
- Switch on the compressor again and check how it runs.

4.5 Hydraulic Connections



WARNING/DANGER



The water you use may contain impurities and/or substances damaging to the system and even harmful to your health. Make sure you use water with quality fitting for home consumption. The following table indicates some parameters according to which water must be subjected to chemical treatment.

Hardness (°dH)	pH	Treatment
3,0 up to 20,0	6,5 up to 8,5	No
3,0 up to 20,0	<6,5 up to >8,5	Yes
<3,0 or >20,0	-	Yes

To assemble the couplings of the hydraulic circuit you must:

- a) Connect the water inlet and outlet of the equipment with a pipe and fittings that can cope with constant temperature / pressure of 75 °C / 7 bar. For this reason, we recommend the use of piping with resistance to high temperature and pressure. We recommend the use of pipe type PEX, PPR, MULTICAMADA, amongst others;
- b) It is necessary to install a safety device at the cold water inlet of the appliance. The safety device must be in compliance with the standard EN 1487:2002, maximum pressure 7 bar (0.7 MPa);
- c) Besides this device, other components will be necessary to ensure the interruption of the hydraulic load, installed according to this sequence:
 - Retainer valve / gate valve
 - Pressure throttle valve (in case the cold water inlet pressure exceeds 4.5 bar)
 - Safety valve / discharge valve
 - Expansion tank

The safety/discharge valve must be connected with piping whose diameter is not less than the cold water inlet coupling. The discharge must be connected to a sewage siphon or, if this is not possible, elevated to a distance of at least 20 mm from the pavement to allow visual inspection.

 WARNING	<p>We recommend the installation of a shut-off / section valve between the gate valve and the coupling to the storage water heater for the purpose of maintenance, safety or emergency.</p> <p>The manufacturer is not responsible for damage related <u>to not following these recommendations / warnings.</u></p>
---	---

4.6 Electrical Connections

To establish the electric connection of the equipment, check these conditions:

- a) The thermodynamic equipment must be plugged to the power supply only after filling the storage water heater;
- b) The thermodynamic equipment must be connected to a monophasic voltage (230 VAC/50Hz or 60Hz* (version of the equipment produced only by specific request);
- c) The connections must comply with the standards of installation in effect in the territory or country where the thermodynamic equipment has been installed;
- d) Earth wiring is obligatory.

It's recommended that the installation includes:

- Bipolar circuit-breaker with connection cable with section equal or higher than 2,5mm.
- Protection differential circuit breaker of 30 mA.

 WARNING	<p>The safety thermostat of this thermodynamic equipment must not, under any circumstance, undergo any repair outside the installations of the manufacturer. Not complying with this clause invalidates the warranty of the equipment.</p>
---	--

The models on the table below are supplied with the following supply cables:

Model	Eco - 1 panel/	Eco - 2 panels	Eco 500 – 2 panels
Wire section	1,5mm ²	1,5mm ²	2,5mm ²

4.6.1 Wiring diagram (1/2 Thermodynamic Panel)

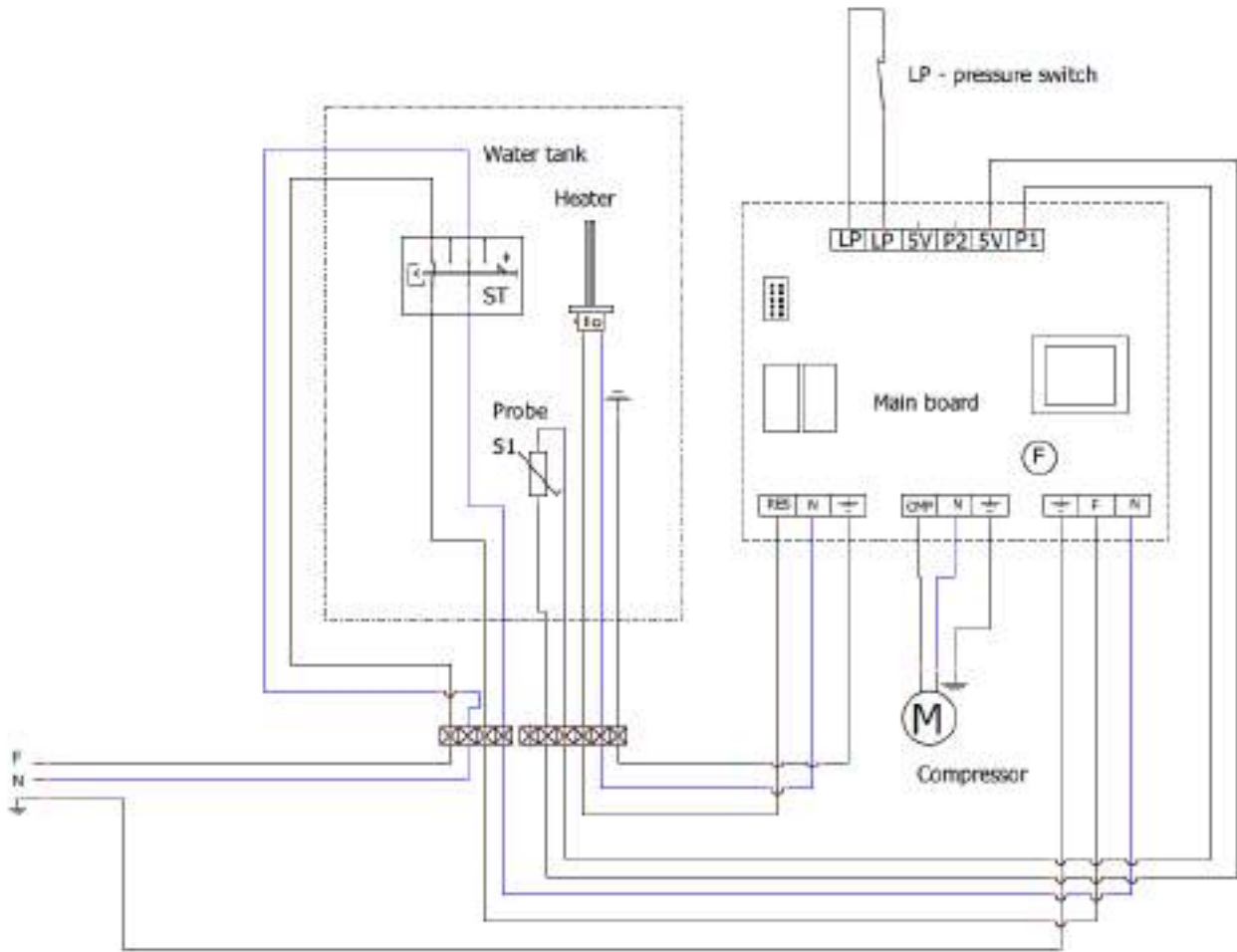

S1 Temperature probe
LP Low pressure switch

Comp Compressor
Heater Support electrical heater

4.6.1 Wiring diagram (ECO 500)

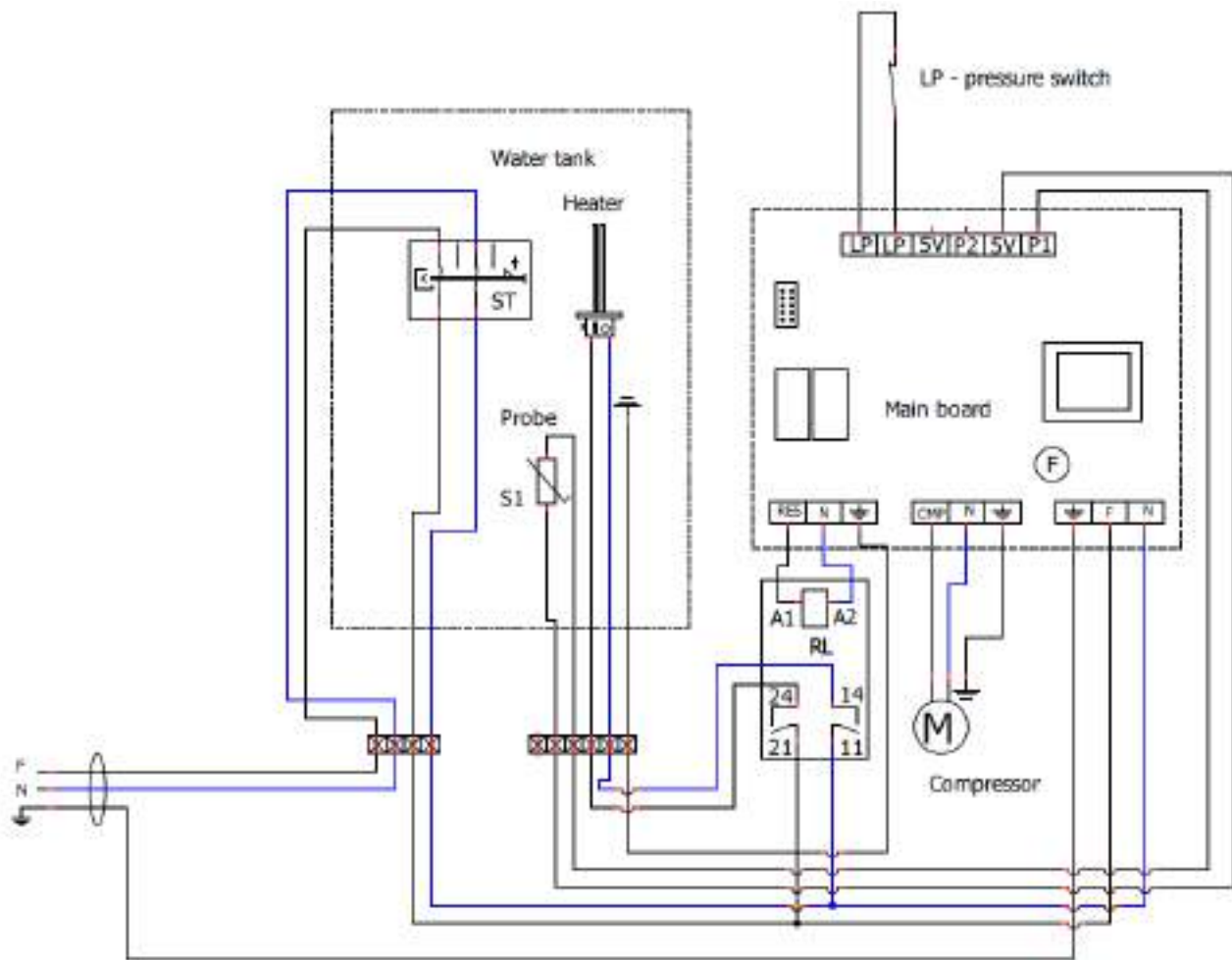

S1 Temperature probe
LP Low pressure switch
Comp Compressor

Heater Support electrical heater
RL Relay
ST Safety thermostat

5 FIRST USE

5.1 Filling the Tank

- Open a cold water tap / isolation valve next to the safety group (this procedure is also used to check if the drain valve is closed);
- After obtaining flow in the hot water tap(s), shut it. Your water heater is full;
- Check the tightening in the pipes;
- Carry out successive discharges through the safety valve, in order to guarantee the proper functioning of all hydraulic components of the installation.

5.2 Start Up of the System

Before starting the **ECO**, check whether the installation is set up according to the recommendations and that everything is in conformity, then you may plug your equipment to the power supply. After switching on your equipment, you should wait a few seconds until the controller begins to work. Then you may start your equipment following these instructions:



- Startup screen;
- System is shut off. Press key ON/OFF to turn on the system;
- Press the key COMP to start up the system;
- System is running;
- Setpoint has been reached.

Note 1: The LED on the ON / OFF button indicates the status of your device. If it is flashing, the equipment does not have any operating order. If the light is on, your equipment is operating in one of the available modes.

6 SYSTEM OPERATION

6.1 Control Panel

The control panel of the Thermodynamic Solar system ECO is simple and intuitive. It enables the configuration of several operating parameters according to the operating mode selected by the user. It comprises six command keys that enable checking the running of the equipment, consult and change parameters:













- ON / OFF / CANCEL;
- MENU;
- COMP;
- E-HEATER;
- DISINFECT;
- OK / LOCK.



6.2 Keys (Functions)



Key	Function	Description
ON/OFF CANCEL	(ON/OFF) Switch on/off	Switch on and off controller
	(CANCEL) Exit	ESC function to exit menu, submenu or cancel a function.
OK /	(OK) Confirmation	Confirm parameters within menus or submenus
	(LOCK) Lock/ Unlock	Lock or unlock keyboard
MENU	MENU	Access the menu.
COMP	ON/OFF Compressor	Switch on / off the Compressor.
E-HEATER	ON/OFF Electrical Heater	Pressing the key allows you to switch on and off the electrical heater
	Change values	Function to run through menus and submenus (inside Menu). It allows you to alter value of parameter.
	Browse Menus/Submenus	
DISINFECT	(DISINFECT) Anti-legionella	Press this key and the system will automatically create a thermal shock in the water to neutralize bacteria (Legionella).

6.3 Interface Symbols

 ECO	Equipment in ECO operating mode
AUTO	Equipment in AUTO operating mode
 BOOST	Equipment in BOOST operating mode
 C	Compressor
 E	Electrical heater
 K	Unlocked keyboard
 L	Locked keyboard
 T	Timer activated after error of LP
 D	Disinfect function is active
 H	Holiday mode is active
 A	Error alarm (visible on display during error)
 M	Error memory (visible on display during 24h)
 °C	Water temperature scale in storage water heater
T_A	Electrical heater is activated when P02 < P08 and/or P07 < Temp. S3 (Auto Mode)
T_c	Electrical heater is activated when time for continuous running of Compressor is over T05 (Auto Mode)
LP	Electrical heater is activated by opening of LP contact (Auto/Boost Mode)
M	Electrical heater is manually activated

6.4 Operating Modes

ECO is programmed to work in 3 running modes, **ECO**, **AUTO** and **BOOST**, which are summarized in this table:

Modo	Simbologia	Funcionamento
ECO	 ECO	Normal running as Thermodynamic System
AUTO	 AUTO	Optimized management of running of Thermodynamic System and/or Electrical Heater (support)
BOOST	 BOOST	Running of Thermodynamic System + Electrical Heater (support)

The equipment is configured by default to work in the “**ECO**” operating mode. If the user finds it necessary to change the operating mode, he must carry out the following procedures:

Unlock the keyboard and press the **Menu** key; on the **▲ ▼** keys, scroll through the menu and select **F03**, access the submenu and select the desired operating mode

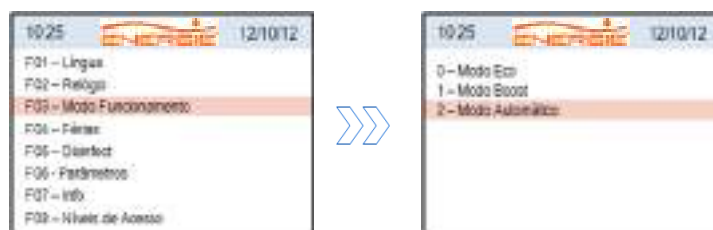

6.4.1 ECO Operating Mode

In ECO operating mode, the equipment runs only as a Heat Pump to heat the water in the storage water heater. Thus, we could generate a greater efficiency, and savings for the user. Every time the user feels it necessary, may switch on the support electrical heater, using this mode, manually pressing the key (E-HEATER). In these circumstances the equipment will automatically change operating mode to BOOST and indicates the reason of its activation (over the electrical heater). If you switch off the electrical heater manually, the equipment will begin to run again in ECO mode.

6.4.2 AUTO Operating Mode

In AUTO operating mode, the equipment will run as a Thermodynamic System and/or electrical heater, and the operation of the electrical heater is managed in an optimized way for the purpose of keeping up the efficiency of the equipment.

The electrical heater will start every time:

- The user activates it manually (key E-Heater).
- The contact LP opens (low external temperature, lack of fluid, leak in the circuit, etc.).
- The time for running the compressor exceeds parameter T05*
- The water temperature is below P08*.

*Parameter is adjustable (ON / OFF)

6.4.3 BOOST Operating Mode

In BOOST operating mode, the equipment runs as a Heat Pump + Electrical Heater, and the running of the electrical heater is simultaneous with the Heat Pump. This mode enables the user to obtain hot water in less time.



The user can change the operating mode when he wishes, he need only press simultaneously the keys MENU + OK/LOCK for 3 seconds and select the mode that suits his needs with the cursor.

6.5 Extra Modes

6.5.1 DISINFECT Function

The **ECO** electronic controller is enabled with the **Disinfect** function, which consists of a water heating cycle at 65 ° C, for an appropriate period of time to prevent the formation of germs in the tank.

The **Disinfect** function can be configured automatically or manually. In automatic mode the user has the possibility to configure the execution of the function daily, weekly or monthly, being inactive the user has to activate it manually in the **Disinfect** button. At the end of the function, the system returns to the operating mode initially adopted.

The Disinfect function is activated:

- When pressed the disinfect button for 3 seconds;
- On the penultimate day of the holiday period (during the holiday period the value adopted in the disinfect parameter must be null);
- Depending on the configuration adopted in the disinfect parameter;
- The disinfect function is deactivated when the **CANCEL** or **COMP** key is pressed.

6.5.2 VACATION Mode

To activate the **vacation** function, you need to access the menu and set the number of days on holiday that you wish, and your equipment will automatically enter **Standby** mode until the last day of holidays. On the last day, the equipment will begin the **Disinfect** function to eliminate any formation of germs that appeared in the storage water heater during the time you were absent. After the holidays and once the program Disinfect is over, the equipment will resume the mode selected (**ECO**, **AUTO** or **BOOST**).

Note: If you set your equipment to enter Vacation mode and turn it off with the key ON/OFF, the function becomes inactive. When you return from your holidays you must remember to switch on your equipment and cancel the days of holidays introduced (Value=0). If you do not carry out this operation, your equipment will not restart until the days of holidays selected have expired.

6.5.3 PV Mode

The PV function offers the possibility to raise the water temperature when an alternative electrical energy source is available (solar photovoltaic, wind or other), increasing the efficiency of the heat pump and making the alternative electrical energy source more profitable.

To do this, simply connect a cable from the inverter to the equipment control board. The cable connection on the control board must be made at the 5V / P2 terminals. Note that this is a dry contact (no voltage), applying a voltage to this contact can cause irreversible damage to the controller.

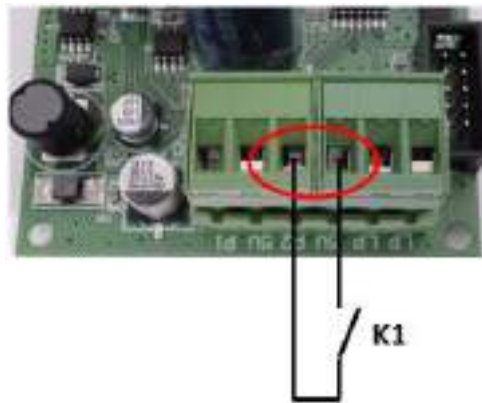

When the K1 contact closes, the **PV** function is activated and all active heat sources (Heat Pump + Electrical Heater) are adjusted to new operating parameters. The compressor will assume the parameters P01PV / H01PV and the electrical heaters the parameters P02PV / H02PV.

Note: when contact K1 opens, the equipment assumes the operating mode previously adopted.

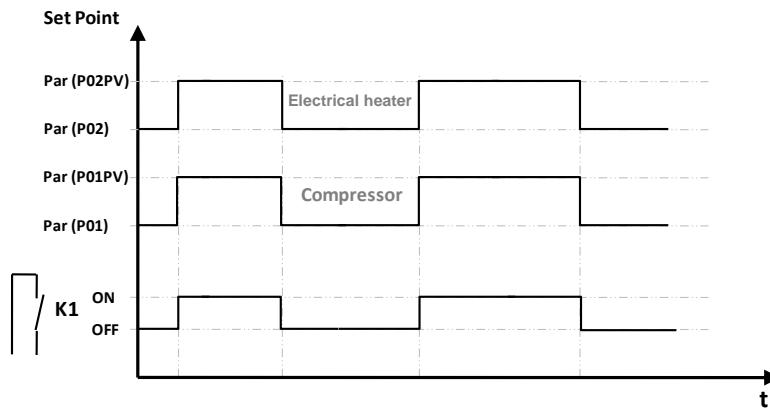

Contact K1 can also be used to take advantage of bi-hourly rates. To do this, simply connect a timer to the 5V / P2 terminals instead of the inverter.

7 SYSTEM MENU

Every time it becomes necessary to change or set new parameters on the equipment, the user must access the Menu.

To access the menu, the key **MENU** must be pressed for 3 seconds.

After access use the keys **COMP ▲** and **E-HEATER ▼**, to navigate the menus and submenus.

In order to confirm values/parameters press the key **OK/LOCK**. Press the key **CANCEL** to exit the menu.

8 ERRORS

Symbols	Description	Problem / Checking
Er01 – S1	Anomaly detected in probe 1	Damaged probe - Measure the probe's internal resistance which at a temperature of 25°C is approximately 10 KΩ.
Er02 – S2	Anomaly detected in probe 2, when applicable	Probe disconnected from the controller - Check that the connector is securely connected to the electronic board and/or that the connection terminals are tight.
E03 – TA	Anomaly detected in water temperature	Water temperature in storage water heater is too hot – Check that there is no anomaly in the electronic board, such as a damaged relay. Temperature probes in short-circuit – Measure internal resistance of probe, it should be approximately 10 KΩ at the temperature of 25°C, check that the connector is well attached to the electronic plate and the connection terminals are in good condition.
Error “Lo”	Temperature probe is damaged or in short-circuit	Check the connections of the temperature probe. Replace with new probe.
LP	Protection system is activated	Check low pressure switch – Check if the connector is well attached to the electronic plate and that the connection terminals are secure, or that the pressure gauge is running. Lack of refrigerant fluid in the circuit – Load of refrigerant incomplete or leak. Low external temperature.
LINK ERROR	Communication failure	Connection cable between display and command panel – Check the cable is in good condition or that the plugs are correctly inserted (display and command panel).

9 PARAMETERS DESCRIPTION

Code	Type	Parameters / Description	Values		
			Min	Max	Default
F01	Language	Português; English; Français; Deutsche; Español; Italiano;	***	***	English
F02	Clock	Date and Time	***	***	***
F03	Mode	Eco Boost Auto	***	***	Eco
F04	Holidays	Number of days	0	366	0
F05	Disinfect	0- Disinfect function inactive 1- Disinfect function active once a week (weekly) 2- Disinfect function active once a month (monthly)	***	***	INACTIVE
F06	Parameters	P01 - Setpoint Compressor 1	10	55	52°C
		H01 - Gradient P01	2	10	3°C
		P02 - Setpoint Electrical Heater	1	65	52°C
		H02 - Gradient P02	2	20	3°C
		P05 - Safety Temperature	70	80	70°C
		P06 - Setpoint Disinfect	60	69	65°C
		P08 - Temp. min water to activate electrical heater	1	40	Value = 16 °C Parameter=ON
		T01 - Delay time to compressor starts running	1	20	2 min
		T05 - Maximum time compressor running (AUTO)	6h	15h	Value = 12 horas Parameter=ON
		T07 - Delay time to compressor starts running after LP error	2	20	10 min
		P01PV - Setpoint Compressor (K1 contact closed)	10	55	55°C
		H01PV - Gradient P01PV	2	10	3°C
P02PV - Setpoint Electrical Heater (K1 contact closed)	1	65	60°C		
H02PV - Gradient P02PV	2	20	5°C		
F07	Info	Information of the values configured in the parameter list.			
F08	Levels of access	Installer	***	***	Password: 0022
F09	Test Outputs	CO - Contact N.O. Compressor output active	OFF	ON	OFF
		RE - Contact N.O. Electrical heater output active			
F10	Errors	Elist - Errors list	***	***	***
		Ereset - Delete errors list	Manufacturer access		
F11	Restore values	Restore all the parameters to factory values	***	***	***
F12	System	Probes' configuration	Manufacturer access		

10 PROBE CHART

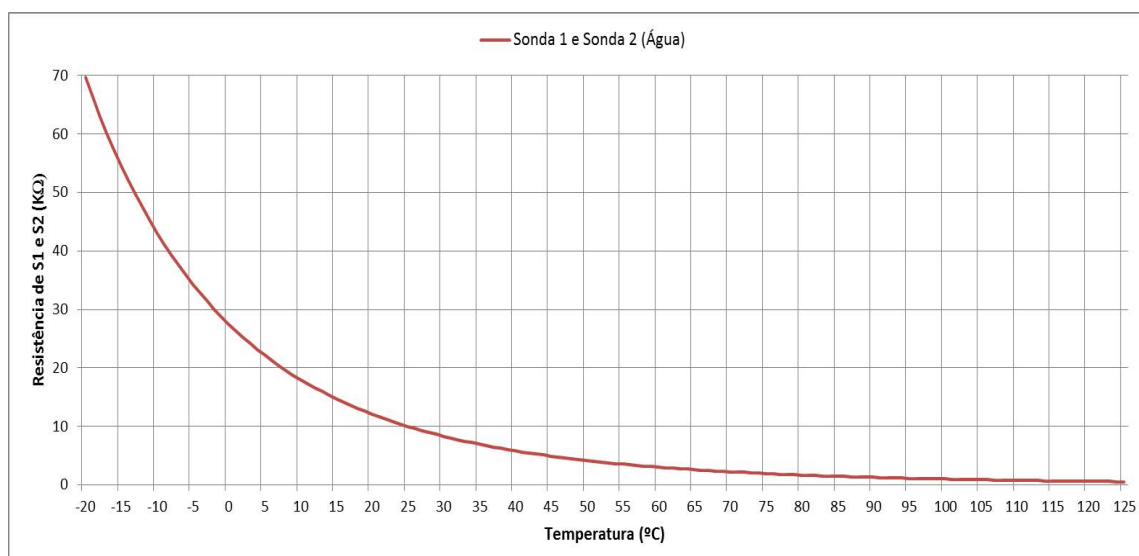

11 TROUBLESHOOTING

Problem	Possible causes	How to proceed
Failure in electronic board	Power supply failure	Check the power supply Check the corresponding circuit breaker
	Cable damaged or disconnected	Check the integrity of the electronic board's electric circuit
Low water temperature	Equipment is switched OFF	Press the key ON/OFF.
	Absence of electrical current or damaged wiring.	Check the connection of equipment to the socket. Check that the corresponding circuit-breaker is connected. Check the integrity of the cables. Check that the electrical cable is disconnected from the electronic. Check electric protection (Fuse RES).
	Component malfunction.	Check the presence of error on electronic board and consult the table of errors.
	Use of large amount of hot water	Set "BOOST" mode and wait for water heating.
	Low temperature programmed in the Setpoint.	Adjust the temperature of the Setpoint.
	ECO mode is selected and outside temperature quite low	Set "AUTO" mode to start automatic management of system. Set "BOOST" mode for a fast water heating.
	Electrical heater is off.	Make sure electrical heater has power supply.
	Compressor is off.	Switch on compressor with key "COMP".
Return of hot water into the cold water circuit (safety device incorrectly installed or damaged)	Shut off the cold water supply valve to switch off the safety device. Open a hot water tap. Wait 10 minutes and if you get hot water, replace the faulty plumbing and/or proceed with the correct positioning of the safety device. Clean the filter of the safety device.	

Problem	Possible causes	How to proceed
Water is too hot and/or there is steam	Problem with the probe. Problem with the thermostat.	Check error display on electronic board. Check correct running of thermostat.
Slow running of thermodynamic solar system and excessive running of electrical heater (AUTO)	Outside temperature is very low	The running of the equipment depends on weather conditions.
	Inlet water temperature is very low	The running of the equipment depends on the inlet water temperature.
	Low value for Setpoint.	Increase the value of Set-point.
	Installation has low electric voltage.	Make sure the installation is supplied with the indicated value for voltage.
	Problems with the thermodynamic solar system.	Check the error display in the electronic board.
Low hot water flow rate	Loss or clogging of hydraulic circuit.	Check the condition of the hydraulic circuit.
Loss of water through safety device	Absence or incorrect dimensioning of expansion tank (if leak is not continuous)	Installation and/or correct dimensioning of expansion tank.
	Pressure in circuit is high (if the leak is continuous)	Check the throttle valve (if there is one installed). Installation of a throttle valve (if it lacks one).
Consumption abnormally high and constant electrical	Loss or obstruction in cooling circuit	Check that the piping is not damaged. Employ equipment suitable for checking leaks in the circuit.
	Dire environmental conditions	
Electrical heater does not work	Thermostat failure	Check the condition of the thermostat.
	Defective electrical heater	Check the condition of the electrical heater.
Bad odour	Absence of siphon or siphon without water	Install and make sure the siphon has water.
Others		Contact customer service.

12 SYSTEM MAINTENANCE

	<p>Before carrying out any maintenance operations on the equipment, make sure that it is not electrically powered! Any intervention must be carried out by a specialized technician.</p>
---	--

12.1 General Inspection

During the equipment's useful life, the owner should carry out a general inspection of the equipment, according to the place where the equipment is set up:

- External cleaning of equipment and surrounding areas with a wet cloth;
- Visual inspection of the whole equipment, with the purpose of detecting possible leaks and damaged devices.

12.2 Magnesium Anode (if applicable)

This equipment has a magnesium anode that together with the building material of the tank will provide an effective protection against corrosion.

The internal shielding of the tank will ensure an effective protection against corrosion contributing to a water quality within the parameters considered normal. However, the characteristics of the water change according to the installation. (See Chapter 4.5 and warranty)

In your living area, the quality of the water can be aggressive to your equipment. So together with the equipment there is a magnesium anode that wears over time, thus protecting your equipment.

The wear of the anode always depends on the characteristics of the water you use. Thus, checking the condition of the anode is very important, particularly in the first years of the installation. To check the condition of your anode, follow these steps:

- Unplug the appliance from the power supply
- Shut off water supply
- Remove pressure (for example, open a hot water tap)
- Unscrew the anode with a suitable tool
- Check the level of wear of the anode and replace it, if necessary
- If the diameter of the anode is less than 15mm, it will need to be replaced



The extension of the deposit's anti-corrosion guarantee is conditioned to the sending of documentary proof of the **annual** replacement of the magnesium anode.

12.3 Filter of Reduction Valve

To periodically clean the filter of the reduction valve, you should:

- a) Shut off the water supply;
- b) Turn anti-clockwise until you remove tension from the spring;
- c) Remove the handle;
- d) Remove filter and clean.

12.4 Safety Thermostat

The safety thermostat is disarmed whenever there is an anomaly in the system, so, whenever you want to rearm it, find out what happened for it to have acted.

If you do not find out what happened and it is still disarmed, contact after-sales service to have your case resolved.

If everything is in order and you want to reset the thermostat, proceed as follows:

Remove the bonnet by loosening the four screws present;

- Unscrew the cover (1);
- Press button (2) to reset the thermostat;
- Retighten the cover (1) and replace the bonnet, tightening the four screws again.



12.5 Empty the Water Storage

 <p>WARNING</p>	<p>Remember that the water in the storage water heater is at a high temperature, so there is an associated risk of burns. Before emptying the storage water heater, allow the water temperature to drop to a level that avoids burns.</p>
---	---

After ensuring the water temperature is at a safe level that will avoid burns, follow this procedure:

- Unplug the system from the power supply;
- Shut off the water supply valve and open a hot water tap;
- Open the system discharge valve.

13 DISPOSAL OF EQUIPMENT

The appliance contains refrigerant gas R134a, which should not be released into the atmosphere. In case of permanent deactivation of the equipment, please contact a qualified technician for the purpose.



The crossed-out wheellie bin symbol on the seal with features indicates that the product, at its end-of-life, must be treated separately from household / urban waste. It must be delivered to a separate collection centre for electrical / electronic equipment or returned to the retailer at the time of purchasing new equipment. The end-user is responsible for delivering the end-of-life device to an appropriate collection centre. Appropriate differentiated delivery for recycling, treatment, and the environmentally compatible disposal of the equipment helps to avoid possible harmful effects on the environment and health, favouring the recycling of the materials that make up the product. For more detailed information on the available collection systems, please contact your local waste disposal service or the organization where you purchased the waste.

END

Warranty

This warranty covers all defects to the confirmed materials, excluding the payment of any type of personal damage indemnity caused directly or indirectly by the materials.

The periods indicated below start from the purchase date of the apparatus, 6 months at the latest from the leaving date from our storage warehouses.

Water Cylinder

(Domestic and Industrial)

5 Years: Stainless Steel (2+3 Years)*

5 Years Enamelled (2+3 Years)*

Manufacturer Warranty

Thermodynamic

Solar Panel

10 years against corrosion

Electrical components and moving parts:

- Thermodynamic Block
- Solar Block
- Solarbox
- Split
- Monobloc (except cylinder)
- Thermobox
- Inverter

2 Years

*The warranty extension of 3 years, against corrosion of the internal tank (Enamelled / Stainless Steel), is conditioned to the submission of:

- Warranty and Check Sheet at maximum 15 days after the installation.
- Documental evidence of the magnesium anode annual replacement (if applicable).
- Pictures of the installation where it's shown safety group, expansion vessel, hydraulic and electrical connections.

In case of warranty, the parts replaced are property of the manufacturer. A repair under the warranty is not reason for an extension of its term.

Warranty Exclusions

The warranty ceases to be effective when the apparatus is no longer connected, used or assembled in accordance with manufacturer instructions, or if there has been any form of intervention by unauthorized technicians, has the appearance of modifications and/or if the series number appears to have been removed or erased. The equipment should be installed by qualified technicians according to the rules in effects and/or the rules of the trade, or the instructions of our technical services. Further exclusions from warranty:

- Hot water tanks have been operating in water with the following indexes:
 - o Active chlorine > 0.2 ppm
 - o Chlorides > 50 mg/l (Inox)
 - o Hardness > 200 mg/l
 - o Conductibility > 600µS/cm (20°C)
 - o PH < 5,5 or PH > 9 (Sorensen at 20°C)
 - o Magnesium > 10 mg/l
 - o Calcium > 20 mg/l
 - o Sodium > 150 mg/l
 - o Iron > 1 mg/l
 - o If one of the water parameters has a higher value than stipulated by directive 236/98 (Portugal) or equivalent standard in the costumer's country
- Parts are subject to natural wear and tear – levers, switches, resistances, programmers, thermostats, etc.
- Breakdown due to incorrect handling, electrical discharges, flooding, humidity or by improper use of the apparatus.
- The warranty lapses if it is transferred to another owner, even if within the guarantee period.
- The warranty lapses if this certificate is incorrectly filled in, if it is violated or if it is returned after more than 15 days have passed since the installation or purchase date of the apparatus.

NOTE: This sheet must be properly filled, signed and stamped by the installer / reseller and returned to ENERGIE EST, Lda., otherwise the warranty will not be validated.

Send this installation sheet to warranty@energie.pt, writing the serial number of the equipment as subject.



Informação mais detalhada em energie.pt



Siga-nos em
ENERGIE PORTUGAL

Morada: Zona Industrial de Laundos, Lote 4B
457B-311 Laundos - Póvoa de Varzim PORTUGAL
Coordenadas GPS: N 41 27,215° - W 6 43 669°
Telefone: + 351 252 600 230

Fax: + 351 252 600 239
E-mail: energie@energie.pt
Web: www.energie.pt

Projeto co-financiado por:



O presente folheto foi criado apenas para informar e não constitui uma oferta comercial para a ENERGIE Lda. A ENERGIE Lda Lda, por meio do presente folheto de acordo com o teor dos seus dados técnicos, não é dada qualquer garantia expressa ou implícita que toda a totalidade, produção, fabricação ou abastecimento para um determinado fim de uso ou trabalho ou de qualquer natureza. As suas finalidades são apenas informativas e não devem ser usadas para qualquer finalidade. A ENERGIE Lda Lda não garante a duração ou a qualidade de qualquer produto ou serviço que seja fornecido ou utilizado com o presente folheto.